

# Posa

Light, since 2007

2022-2023

## SENSOR LIGHTS SENSORS

ENERGY-SAVING  
SMART LIGHTS

# Posa

NINGBO POSA TECH CO., LTD.

📍 Office Add: No.1108,Jiangnan Rd, Hi-Tech Park, 315040 Ningbo, China

📍 Factory Add: No.15, Jingwu middle rd, Xiaogang, Beilun Zone, 315800 Ningbo, China

☎ Tel: 0086-574-8733 6707    0086-574-8752 9365

📠 Fax: 0086-574-8733 4848

✉ E-mail: info@posa-tech.net

🌐 Web: www.posa-tech.net

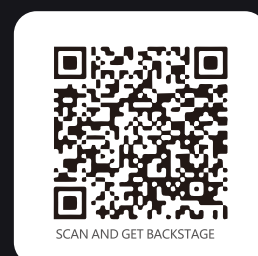

The company reserves the right to change product design, specifications and parameters without prior notice. Please refer to the product specification.

Printing may make the products in the materials different from the real ones. All the materials are carefully proofread. If there are any printing mistakes, the company will not bear the consequences.

The company reserves the right of final interpretation of the information.

NINGBO POSA TECH CO., LTD.

# POSA

PoSa Tech is your reliable partner in China for the professional innovation electronics and lightings, especially sensor related products. The demands on lighting have changed dramatically in recent years. Modern lighting should be energy-efficient while also giving people every convenience. We pursue a smart and eco saver life for the person who uses our products. Until now our engineer has invented wireless linking sensor lights, dimmable sensor light, emergency lights. We can also combine all these function in one light.

In PoSa, 100% products are exported. We pay attention to the quality, customer request and target market's certification. The main customers of our company include Eastern, Western Europe, North, South Africa and Asia.

### The Products

We offer :

- Sensors including microwave motion sensor, PIR motion sensor and photocell sensor.
- LED ceiling/wall lights.
- LED ceiling/wall lights with additional function: standard motion sensor lights, dimmable motion sensor lights, wireless linking & dimmable motion sensor lighting.
- LED ceiling/wall lights with additional function: emergency lights, emergency motion sensor lights, dimmable emergency sensor lights.
- LED tri-proof lights with/without above mentioned functions.

### The Technology

One of the foundations is high quality of the products. Our specialists from the Development Department are constantly working on increasing quality standards. We offer the technical solution before and after sale. To be a qualified supplier for the high-level market, most of PoSa Tech products have CE, ETL, LVD, GS, UL, R&TTE approval. We are RoHS compliant.

We welcome OEM & ODM projects, design and produce tailor to the customer's request. Our goal is growth with our customers.





**POS**

# PRODUCT CATALOG



## CONTENTS

● LED Ceiling Light	01-14
● Outdoor Wall Light	15-18
● LED Flood Light	19-22
● LED Work Light	23-25
● LED Rechargeable Work Light	26-28
● LED Bulb	29-34
● LED Tri-proof Tube Light	35-36
● LED Down Light	37-38
● LED Down Light and LED Panel Light	39-40
● LED Panel Light	41-42
● Microwave Motion Sensor	43-50
● PIR Motion Sensor	51-54

# LED CEILING LIGHT



Light, since 2007

## Remote for ON/OFF sensors



### PS-SL78L SERIES

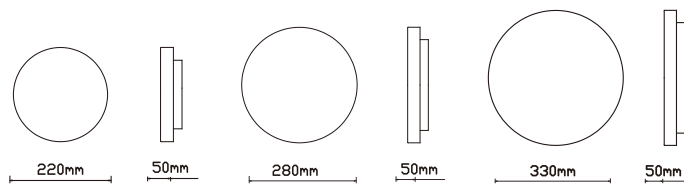

### PS-SL79L SERIES

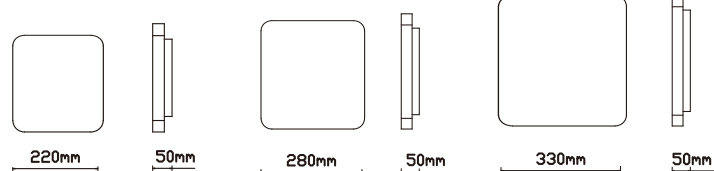

Item No.	Function	Power	Luminous Flux	Material	LED	Meas
PS-SL78L-15W-APP	WIFI, Alexa	15W	0-1350lm	PC/PC	192xSMD2835	Φ220x50mm
PS-SL78L-18W-APP		18W	0-1530lm		384xSMD2835	Φ280x50mm
PS-SL78L-24W-APP		24W	0-2000lm		480xSMD2835	Φ330x50mm
PS-SL79L-15W-APP	WIFI, Alexa	15W	0-1350lm	PC/PC	192xSMD2835	220x220x50mm
PS-SL79L-18W-APP		18W	0-1530lm		384xSMD2835	280x280x50mm
PS-SL79L-24W-APP		24W	0-2000lm		480xSMD2835	330x330x50mm

## Microwave Motion Sensor + Remote Control Function



Item No.	Function	Power	Luminous Flux	Material	LED	Meas
PS-ML78L-15W-RE	Microwave Motion Sensor, Remote Control	15W	1350lm	PC/PC	96xSMD2835	Φ220x50mm
PS-ML78L-18W-RE		18W	1530lm		192xSMD2835	Φ280x50mm
PS-ML78L-24W-RE		24W	2000lm		240xSMD2835	Φ330x50mm
PS-ML79L-15W-RE	Microwave Motion Sensor, Remote Control	15W	1350lm	PC/PC	96xSMD2835	220x220x50mm
PS-ML79L-18W-RE		18W	1530lm		192xSMD2835	280x280x50mm
PS-ML79L-24W-RE		24W	2000lm		240xSMD2835	330x330x50mm

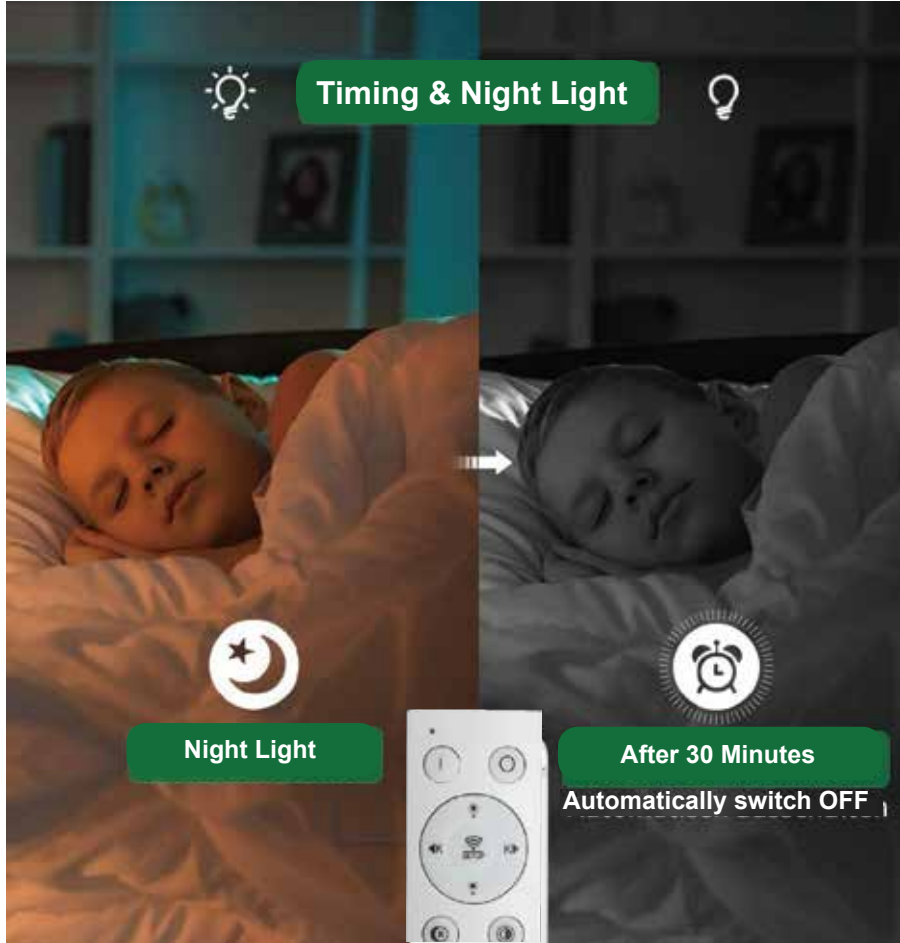

Remote Control LED Ceiling and On/Off LED Ceiling Light

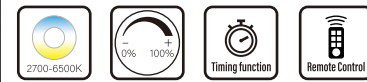

Item No.	Function	Power	Luminous Flux	Material	LED	Meas
PS-CL78L-15W-DCT	Remote Control	15W	max 1350lm(adjustable)	PC/PC	192xSMD2835	Φ220x50mm
PS-CL78L-18W-DCT		18W	max 1530lm(adjustable)		384xSMD2835	Φ280x50mm
PS-CL78L-24W-DCT		24W	max 2000lm(adjustable)		480xSMD2835	Φ330x50mm
PS-CL78L-15W	ON/OFF	15W	1350lm	PC/PC	192xSMD2835	Φ220x50mm
PS-CL78L-18W		18W	1530lm		384xSMD2835	Φ280x50mm
PS-CL78L-24W		24W	2000lm		480xSMD2835	Φ330x50mm
PS-CL79L-15W-DCT	Remote Control	15W	max 1350lm(adjustable)	PC/PC	192xSMD2835	220x220x50mm
PS-CL79L-18W-DCT		18W	max 1530lm(adjustable)		384xSMD2835	280x280x50mm
PS-CL79L-24W-DCT		24W	max 2000lm(adjustable)		480xSMD2835	330x330x50mm
PS-CL79L-15W	ON/OFF	15W	1350lm	PC/PC	192xSMD2835	220x220x50mm
PS-CL79L-18W		18W	1530lm		384xSMD2835	280x280x50mm
PS-CL79L-24W		24W	2000lm		480xSMD2835	330x330x50mm

Microwave Motion Sensor

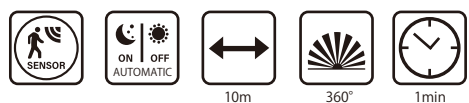

Item No.	Function	Power	Luminous Flux	Material	LED	Meas
PS-ML78L-15W	SENSOR	15W	1350lm	PC/PC	96xSMD2835	Φ220x50mm
PS-ML78L-18W		18W	1530lm		192xSMD2835	Φ280x50mm
PS-ML78L-24W		24W	2000lm		240xSMD2835	Φ330x50mm
PS-ML79L-15W	SENSOR	15W	1350lm	PC/PC	96xSMD2835	220x220x50mm
PS-ML79L-18W		18W	1530lm		192xSMD2835	280x280x50mm
PS-ML79L-24W		24W	2000lm		240xSMD2835	330x330x50mm

12 keys remote controller

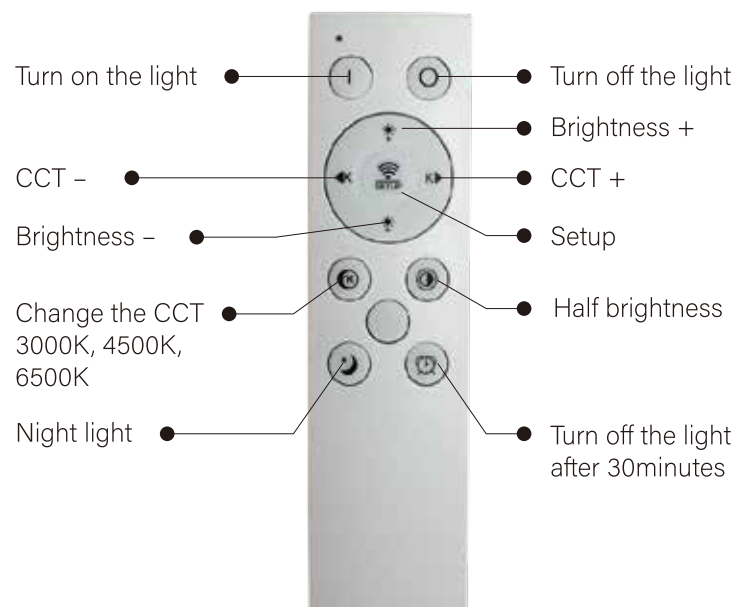

Setup the remote control with the light

When turn on the light at the first time, please press the SETUP button until the LED turn on/off 3 times, can't release until the light turn on/off. Then setup well.

Cancel the SETUP

When turn on the light at the first time, please press the TURN ON THE LIGHT button until the LED turn on/off 3 times, can't release until the LED turn on/off. Then cancel the set.

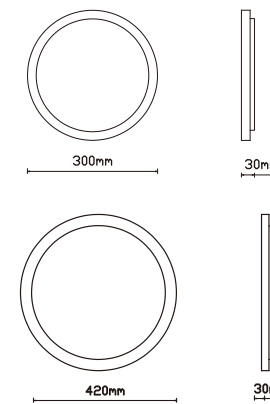

Item No.	Function	Power	Luminous Flux	Material	LED	Meas
PS-SL97L-18W-APP	WIFI	18W	0-1530lm	PMMA+PP	192xSMD2835	Φ300x30mm
PS-SL97L-24W-APP		24W	0-2000lm		276xSMD2835	Φ420x30mm
PS-ML97L-18W-RE	SENSOR	18W	1530lm	PMMA+PP	144xSMD2835	Φ300x30mm
PS-ML97L-24W-RE		24W	2000lm		192xSMD2835	Φ420x30mm
PS-ML97L-18W	SENSOR	18W	1530lm	PMMA+PP	144xSMD2835	Φ300x30mm
PS-ML97L-24W		24W	2000lm		192xSMD2835	Φ420x30mm
PS-CL97L-18W-DCT	Remote Control	18W	max 1530lm(adjustable)	PMMA+PP	144xSMD2835	Φ300x30mm
PS-CL97L-24W-DCT		24W	max 2000lm(adjustable)		192xSMD2835	Φ420x30mm
PS-CL97L-18W	ON/OFF	18W	1530lm	PMMA+PP	192xSMD2835	Φ300x30mm
PS-CL97L-24W		24W	2000lm		276xSMD2835	Φ420x30mm



Item No.	Function	Power	Luminous Flux	Material	LED	Meas
PS-SL98L-24W-APP		24W	0-2160lm	ABS/PS	48xRGB SMD5050 192xSMD3030	Φ 300x40mm



Item No.	Function	Power	Luminous Flux	Material	LED	Meas
PS-CL96L-20W	ON/OFF	20W	1600lm	PP	28xSMD2835	Φ 200x55mm
PS-CL96L-30W	ON/OFF	30W	2400lm		42xSMD2835	Φ 300x55mm
PS-CL96L-40W	ON/OFF	40W	3200lm		56xSMD2835	Φ 400x55mm



Dimmable Microwave Motion Sensor LED Ceiling Light



Item No.	Function	Power	Luminous Flux	Material	LED	Meas
PS-ML16L-D		16W	940lm	PC/PC	80xSMD5050	Φ300x120mm
PS-ML17L-D		20W	1300lm	PC/PC	40xSMD5730	Φ350x120mm
PS-ML18L-D		24W	1510lm	PC/PC	48xSMD5730	Φ400x135mm
PS-ML16L		16W	1350lm	PC/PC	72xSMD2835	Φ300x120mm
PS-ML17L		20W	1400lm	PC/PC	40xSMD5730	Φ350x120mm
PS-ML18L		24W	1510lm	PC/PC	52xSMD5730	Φ400x135mm
PS-CL16L	ON/OFF	16W	1350lm	PC/PC	72xSMD2835	Φ300x120mm
PS-CL17L	ON/OFF	20W	1400lm	PC/PC	40xSMD5730	Φ350x120mm
PS-CL18L	ON/OFF	24W	1510lm	PC/PC	52xSMD5730	Φ400x135mm

Dimmable Microwave Motion Sensor LED Ceiling Light

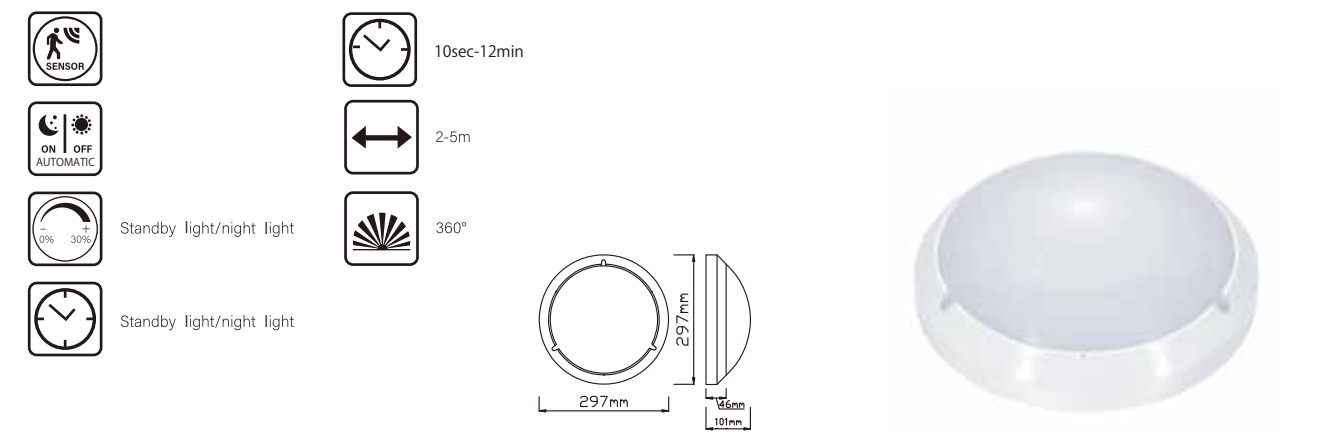

Item No.	Function	Power	Luminous Flux	Material	LED	Meas
PS-ML106L-2835		16W	1030lm	PC/PC	96xSMD2835	Φ300x120mm
PS-CL106L-2835	ON/OFF	16W	1030lm	PC/PC	96xSMD2835	Φ300x120mm



**Dimmable Microwave Motion Sensor LED Ceiling Light**



standby light/ night light



1min- all night



3-10m



360°



10sec-10min

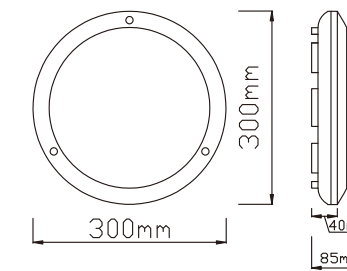

Item No.	Function	Power	Luminous Flux	Material	LED	Meas
PS-ML35L-D-20W		20W	1500lm	PC/Aluminum die-casting	120xSMD2835	Φ300x85mm
PS-CL35L-20W	ON/OFF	20W	1500lm	PC/Aluminum die-casting	120xSMD2835	Φ300x85mm

**Dimmable Microwave Motion Sensor LED Ceiling Light**



standby light/ night light



1min- all night



3-10m



360°



10sec-10min

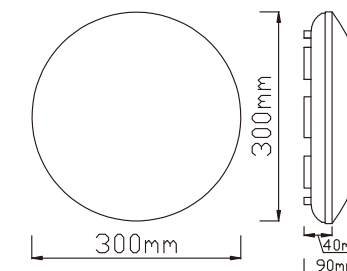

Item No.	Function	Power	Luminous Flux	Material	LED	Meas
PS-ML36L-D-20W		20W	1500lm	PMMA/Aluminum die-casting	120xSMD2835	Φ300x90mm
PS-CL36L-20W	ON/OFF	20W	1500lm	PMMA/Aluminum die-casting	120xSMD2835	Φ300x90mm





**Microwave Motion Sensor LED Ceiling Light**



5sec/3min/8min/12min



2m/4m/6m/10m



360°

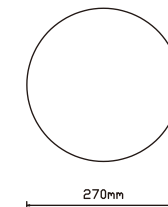

Item No.	Function	Power	Luminous Flux	Material	LED	Meas
PS-ML80L		15W	1350lm	PC/PC	96xSMD2835	Φ220x50mm
PS-CL80L	ON/OFF	18W	1530lm	PC/PC	192xSMD2835	Φ280x50mm

**Microwave Motion Sensor LED Ceiling Light**



1min



10m



360°

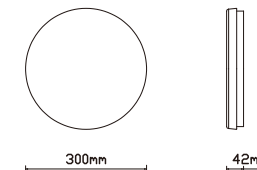
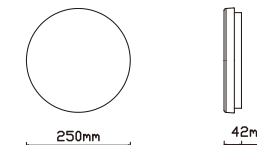

Item No.	Function	Power	Luminous Flux	Material	LED	Meas
PS-ML81L		12W	1000lm	PC/PC	224xSMD2835	Φ250x42mm
PS-ML81L		15W	1240lm	PC/PC	224xSMD2835	Φ250x42mm
PS-ML81L		24W	2350lm	PC/PC	300xSMD2835	Φ300x42mm
PS-CL81L	ON/OFF	12W	1000lm	PC/PC	224xSMD2835	Φ250x42mm
PS-CL81L	ON/OFF	15W	1240lm	PC/PC	224xSMD2835	Φ250x42mm
PS-CL81L	ON/OFF	24W	2350lm	PC/PC	300xSMD2835	Φ300x42mm



Microwave Motion Sensor LED Ceiling Light

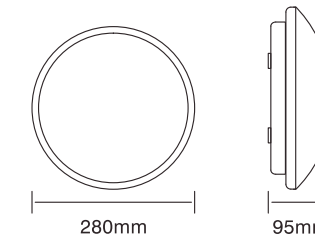

Item No.	Function	Power	Luminous Flux	Material	LED	Meas
PS-ML08L-D-15W		15W	1200lm	Glass/Iron	300xSMD2835	Φ280x95mm

Item No.	Function	Lamp Holder	Power	Material	Meas
PS-ML08		1xE27	1x60W	Glass/Iron	Φ280x95mm
PS-CL08	ON/OFF	1xE27	1x60W	Glass/Iron	Φ300x85mm

# OUTDOOR WALL LIGHT



Light, since 2007

PS-WL29L-2W/PS-WL29L-4W



PS-WL37L-1W

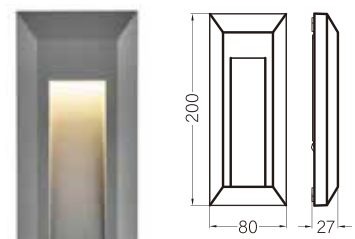

PS-WL36L-3.5W



Item No.	PS-WL29L-2W	PS-WL29L-4W	PS-WL36L-3.5W	PS-WL37L-1W
Power:	2W	4W	3.5W	1W
Voltage:	220-240V			
LED:	24xSMD3528	40xSMD3014	35xSMD3014	9xSMD3014
Luminous Flux	140lm	280lm	180lm	50lm
Material	PC/ABS & PC diffuser, UV resistant			
IP Rating	IP65, Class II			

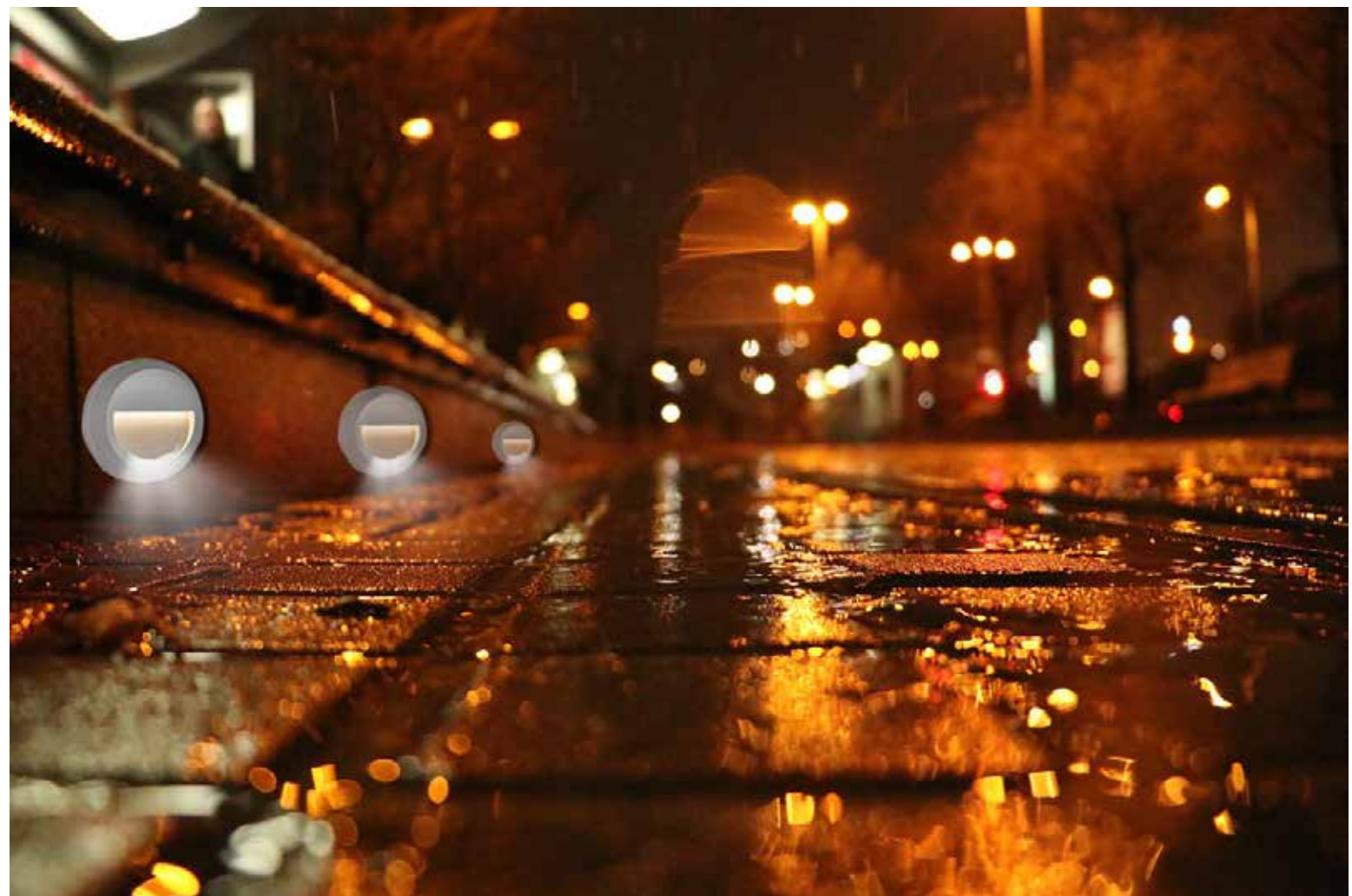

PS-WL38L-4.5W

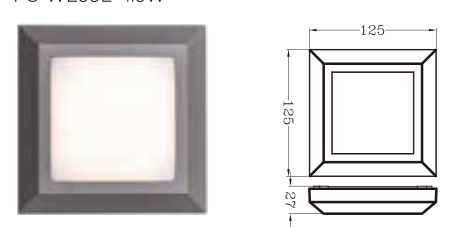

PS-WL40L-3W

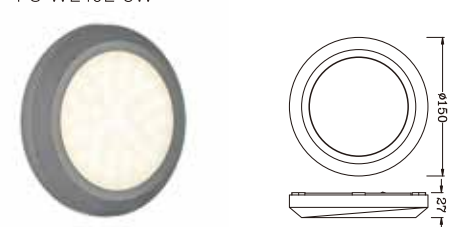

PS-WL39L-1.6W

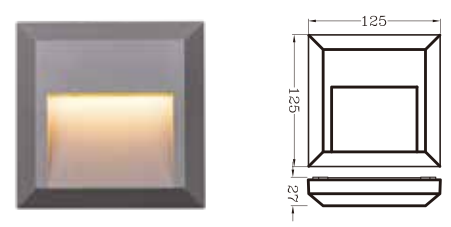

PS-WL41L-1.5W

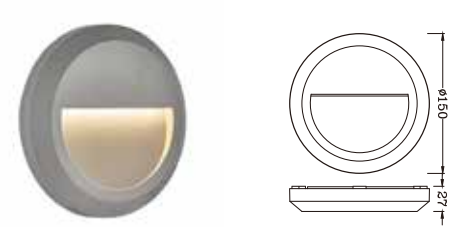

Item No.	PS-WL38L-4.5W	PS-WL39L-1.6W	PS-WL40L-3W	PS-WL41L-1.5W
Power:	4.5W	1.6W	3W	1.5W
Voltage:	220-240V			
LED:	45xSMD3014	16xSMD3014	45xSMD3014	20xSMD3014
Luminous Flux	290lm	120lm	250lm	130lm
Material	PC/ABS & PC diffuser, UV resistant			
IP Rating	IP65, Class II			



Posa

Light, since 2007

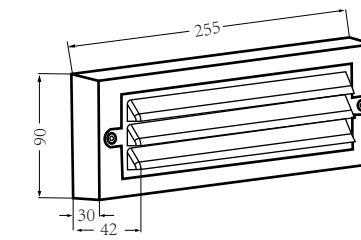

**PS-WL91L-6W**

Power: 6W  
Voltage: 220-240V  
LED: 93xSMD2835  
Luminous Flux: 120lm  
Material: PC/ABS & PC diffuser, UV resistant  
IP Rating: IP65, Class II

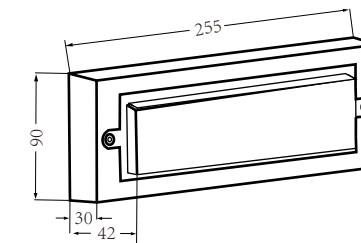

**PS-WL92L-6W**

Power: 6W  
Voltage: 220-240V  
LED: 93xSMD2835  
Luminous Flux: 110lm  
Material: PC/ABS & PC diffuser, UV resistant  
IP Rating: IP65, Class II

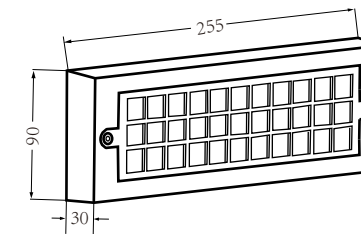

**PS-WL93L-6W**

Power: 6W  
Voltage: 220-240V  
LED: 93xSMD2835  
Luminous Flux: 330lm  
Material: PC/ABS & PC diffuser, UV resistant  
IP Rating: IP65, Class II

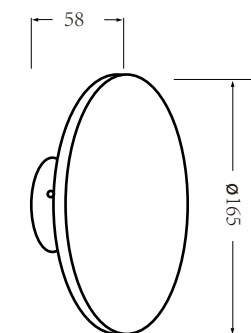

**PS-WL94L-6W**

Power: 8W  
Voltage: 220-240V  
LED: 48xSMD2835  
Luminous Flux: 600lm  
Material: PC/ABS & PC diffuser, UV resistant  
IP Rating: IP65, Class II

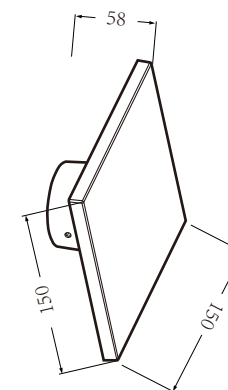

**PS-WL95L-6W**

Power: 8W  
Voltage: 220-240V  
LED: 48xSMD2835  
Luminous Flux: 600lm  
Material: PC/ABS & PC diffuser, UV resistant  
IP Rating: IP65, Class II

# LED FLOOD LIGHT

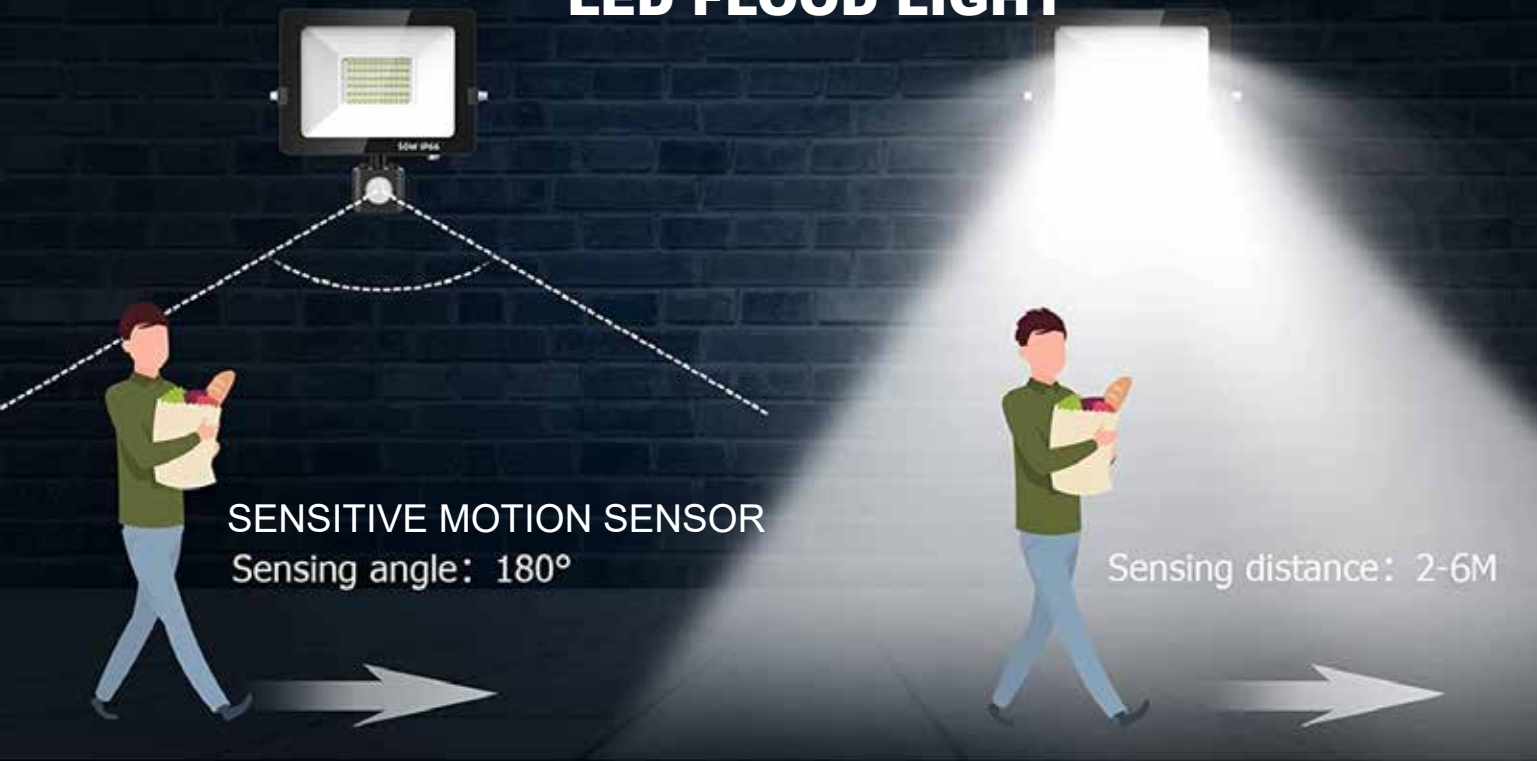

Posa

Light, since 2007

## PIR sensor function



PS-FL-LED081-30W



PS-FL-LED081-100W



### LUX

On "SUN", sensor works whole day.  
On "MOON", sensor only works at night.

### TIME

Set the light sensor sensing time (10 seconds ~ 10 minutes).

### SENS

Adjust the sensor sensing distance (2~6m)

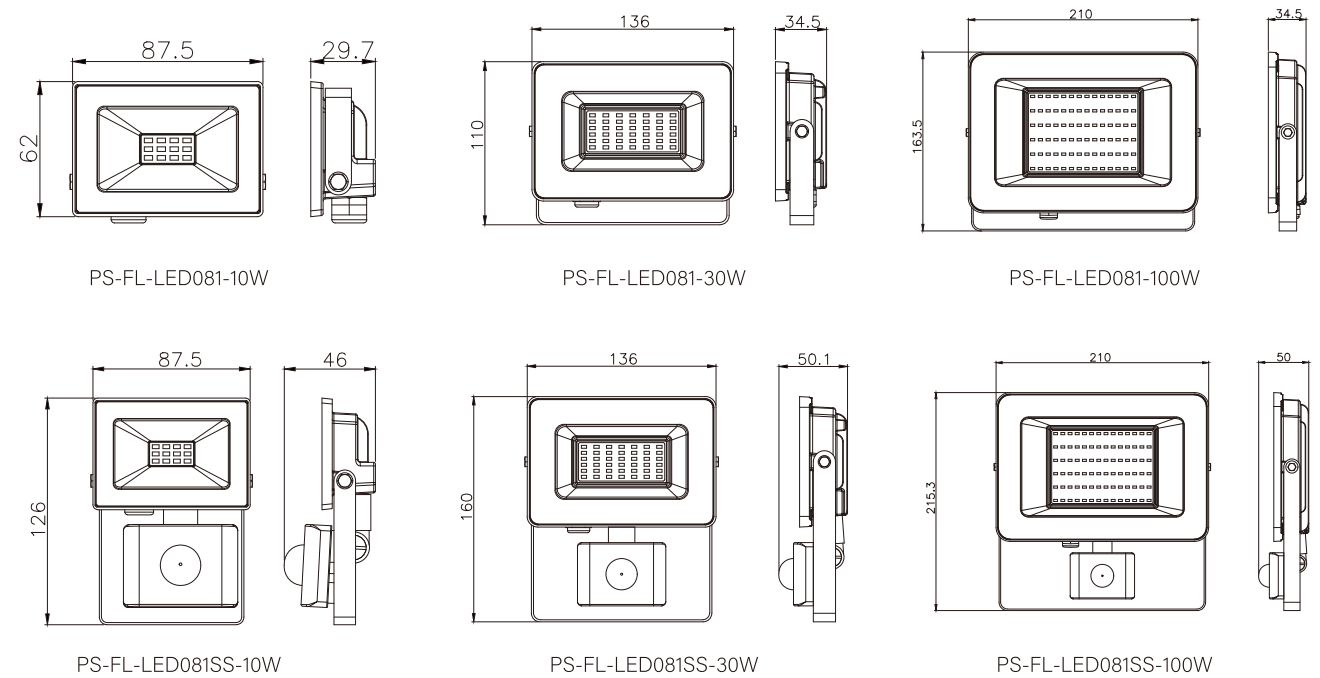

PS-FL-LED081-10W

PS-FL-LED081-30W

PS-FL-LED081-100W

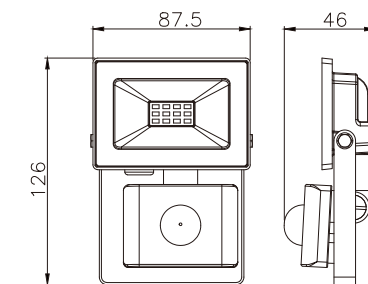

PS-FL-LED081SS-10W

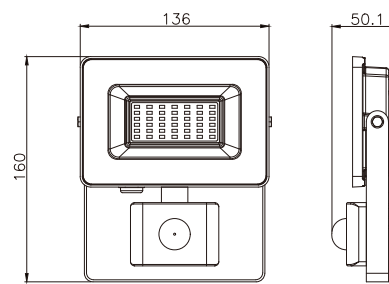

PS-FL-LED081SS-30W

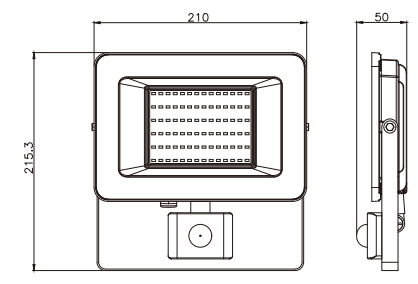

PS-FL-LED081SS-100W



Item No.	Function	Power	Luminous Flux	Material	LED	Meas	IP Rating
PS-FL-LED081SS-10W	ON/OFF	10W	800lm	Aluminium Die-casting body, tempered glasses, steel bracket	12xSMD2835	8.75x12.6x4.6cm	IP 44
PS-FL-LED081SS-20W		20W	1600lm		24xSMD2835	10x14x5cm	
PS-FL-LED081SS-30W		30W	2400lm		36xSMD2835	13.6x16x5cm	
PS-FL-LED081SS-50W		50W	4000lm		60xSMD2835	18x19.6x5cm	
PS-FL-LED081SS-100W		100W	8000lm		96xSMD2835	21x21.53x5cm	
PS-FL-LED081-10W		10W	800lm		12xSMD2835	8.75x6.2x2.9cm	
PS-FL-LED081-20W	20W	1600lm	24xSMD2835	10x7x3.45cm			
PS-FL-LED081-30W	30W	2400lm	36xSMD2835	13.6x11.05x3.45cm			
PS-FL-LED081-50W	50W	4000lm	60xSMD2835	18x14.25x3.45cm			
PS-FL-LED081-100W	100W	8000lm	96xSMD2835	21x16.35x3.45cm			

Remote RGB Flood Light

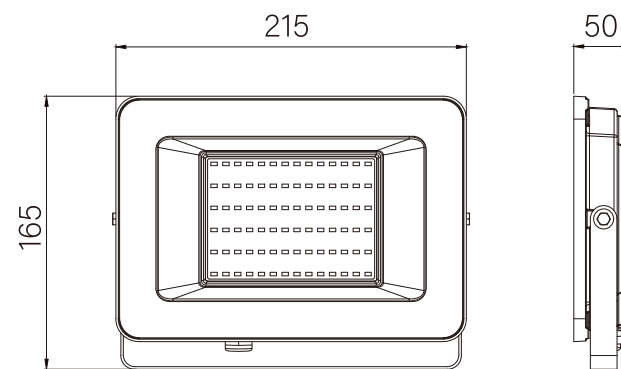
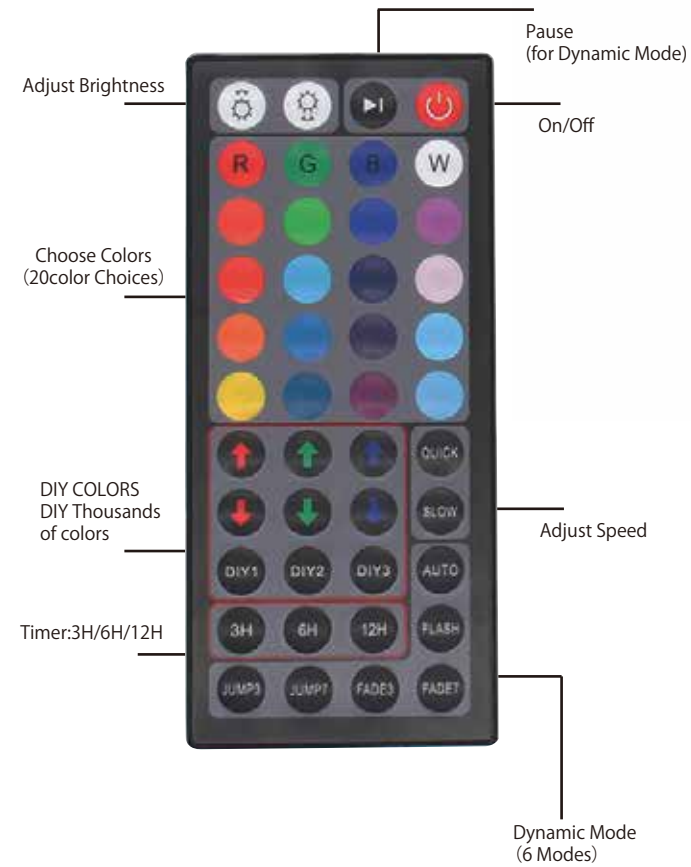

PS-FL-LED082-30W



PS-FL-LED082SS-100W

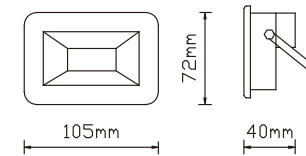

PS-FL-LED082-10W

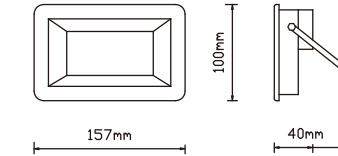

PS-FL-LED082-30W

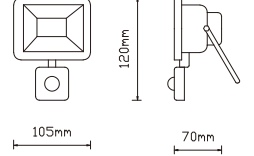

PS-FL-LED082SS-10W

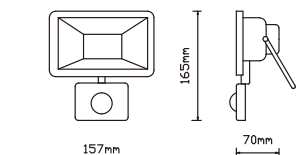

PS-FL-LED082SS-30W

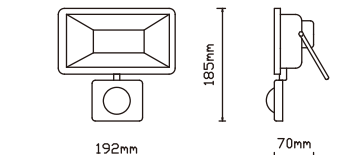

PS-FL-LED082SS-50W

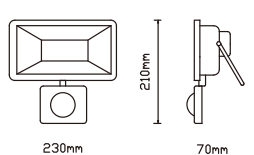

PS-FL-LED082SS-100W

PIR Sensor Function



Item No.	Function	Power	Luminous Flux	Material	LED	Meas	IP Rating
PS-FL-LED081-50W-RGB	RGB Remote Control	50W	4000lm	Die-casting aluminum, tempered glass, spray polyester on the surface	108xSMD2835	21.5x16.5x5cm	IP65

Item No.	Function	Power	Luminous Flux	Material	LED	Meas	IP Rating
PS-FL-LED082SS-10W	PIR SENSOR	10W	900lm	Aluminium Die-casting body, tempered glasses, steel bracket	28xSMD2835	10.5x7x12.5cm	IP 44
PS-FL-LED082SS-20W		20W	1800lm		28xSMD2835	12x7x13.5cm	
PS-FL-LED082SS-30W		30W	2700lm		42xSMD2835	15.7x7x16.5cm	
PS-FL-LED082SS-50W		50W	4500lm		70xSMD2835	19.2x7x18.5cm	
PS-FL-LED082SS-100W		100W	9000lm		140xSMD2835	23x7x21cm	
PS-FL-LED082SS-150W		150W	13500lm		210xSMD2835	28x7.5x25cm	
PS-FL-LED082SS-200W		200W	18000lm		280xSMD2835	32x7.5x28cm	
PS-FL-LED082-10W	ON/OFF	10W	900lm	Aluminium Die-casting body, tempered glasses, steel bracket	28xSMD2835	10.5x4x7.2cm	IP 65
PS-FL-LED082-20W		20W	1800lm		28xSMD2835	12x4x8cm	
PS-FL-LED082-30W		30W	2700lm		42xSMD2835	15.7x4x10cm	
PS-FL-LED082-50W		50W	4500lm		70xSMD2835	19.2x4x13cm	
PS-FL-LED082-100W		100W	9000lm		140xSMD2835	23x4x15cm	
PS-FL-LED082-150W		150W	13500lm		210xSMD2835	28x4.5x19cm	
PS-FL-LED082-200W		200W	18000lm		280xSMD2835	32x4.5x21.7cm	



# LED WORK LIGHT

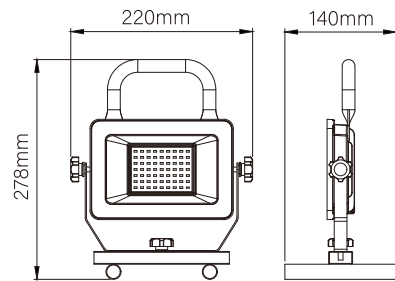

Item No.	Power	Luminous Flux	Material	LED	Meas
PS-FL-LED074-60W	60W	5400lm	Aluminium Die-casting body, PC body, PC reflector, Tempered glass	24xSMD2835	27x22x5.5cm



Light, since 2007

- Input Voltage: AC85-265V, 50/60 Hz
- With 1.5M 3x0.75m2 H05RN-F cable and waterproof plug
- Power Factor: 0.92
- Color Instruction: >80
- Body Color: Black/White/Red/Yellow



Item No.	Power	Luminous Flux	Material	LED	Meas
PS-FL-LED072-10W	10W	800lm	Aluminium Die-casting body, PC reflector, Tempered glass	28xSMD2835	27x22x5.5cm
PS-FL-LED072-20W	20W	1600lm		54xSMD2835	27x22x5.5cm
PS-FL-LED072-30W	30W	2400lm		78xSMD2835	29x26.5x5.5cm
PS-FL-LED072-50W	50W	4000lm		156xSMD2835	31x35x5.5cm
PS-FL-LED072-100W	100W	8000lm		312xSMD2835	35.5x45.5x5.5cm

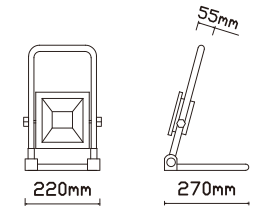

PS-FL-LED072-10W

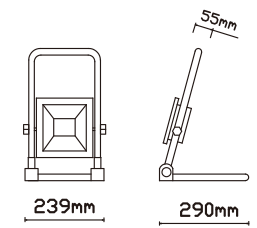

PS-FL-LED072-30W

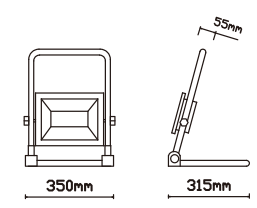

PS-FL-LED072-50W

- Input Voltage: AC85-265V, 50/60 Hz
- With 1.5M 3x0.75m2 H05RN-F cable and waterproof plug
- Power Factor: 0.92
- Color Instruction: >80
- Body Color: Black/White/Red/Yellow



Item No.	Power	Luminous Flux	Material	LED	Meas
PS-FL-LED074-10W	10W	800lm	Aluminium Die-casting body, PC reflector, Tempered glass	28xSMD2835	14.4x15.5x20cm
PS-FL-LED074-20W	20W	1600lm		54xSMD2835	14.4x15.5x20cm
PS-FL-LED074-30W	30W	2400lm		78xSMD2835	16.5x20x24.2cm
PS-FL-LED074-50W	50W	4000lm		156xSMD2835	18.2x24.5x28.7cm
PS-FL-LED074-100W	100W	8000lm		312xSMD2835	27.2x22.3x33.6cm

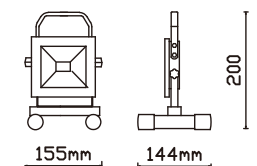

PS-FL-LED074-20W

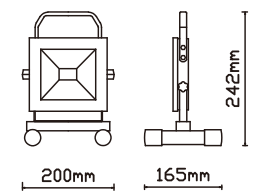

PS-FL-LED074-30W

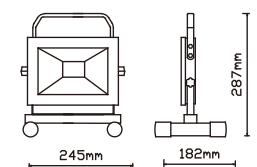

PS-FL-LED074-50W

- Input Voltage: AC220-240V, 50/60 Hz
- Output USB: 5V1A
- With 3M 3×1.5m2 H05RN-F cable and waterproof plug
- Power Factor: 0.92
- Color Instruction: >80
- 0, 50%, 100% dimmable

- Output USB: 5V1A
- Charge / Discharge Time: 3hrs
- With 3M 3×1.5m2 H05RN-F cable and waterproof plug
- Power Factor: 0.92
- 0, 50%, 100% dimmable



PS-WL003-20W-AC



PS-WL002-10W-DC



PS-WL005-2\*20W-AC  
PS-WL005-2\*30W-AC



PS-WL004-2\*10W-DC



0,50%,100%

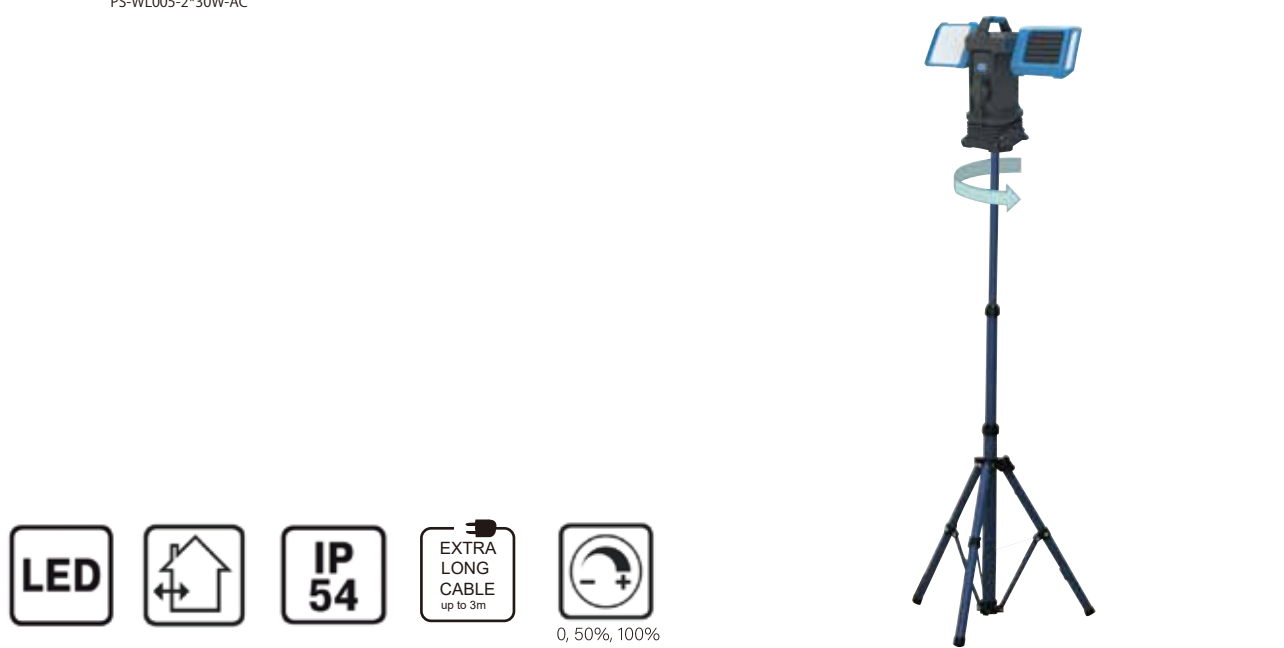

0, 50%, 100%

Item No.	Power	Luminous Flux	Material	Meas
PS-WL003-20W-AC	20W	2000lm		19.8×15×5.5cm
PS-WL005-2*20W-AC	40W	4000lm	PC body, aluminium heat radition	33.4×16.8×14.8cm
PS-WL005-2*30W-A'	60W	6000lm		33.4×16.8×14.8cm

Item No.	Power	Luminous Flux	Material	Battery Capacity	MICRO Charging	Meas
PS-WL002-10W-DC	10W	600lm	PC body,		No	21.35×74.8cm
PS-WL004-2*10W-DC	20W	1200lm	aluminium hea		Yes	33.4×16.8×14.8cm





# LED RECHARGEABLE WORK LIGHT



Light, since 2007

- Material: Aluminium Die-casting body, PC body, PC reflector, Tempered glass
- Current output: 1A

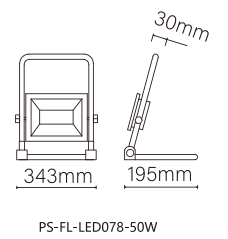
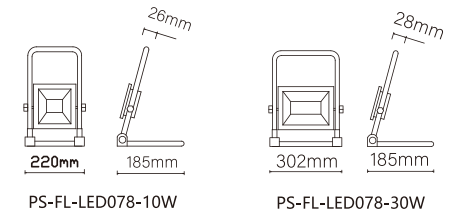

Item No.	Input Voltage	Mains Charger		Car Charger		Power	Luminous Flux	Battery Capacity	Meas
		Input	Output	Input	Output				
PS-FL-LED078-10W	DC4.2V	100V - 240V	DC4.2V	DC12/24V	DC4.2V	10W	400lm	4.2V 2200mAh	22x2.6x18.5cm
PS-FL-LED078-20W	DC4.2V		DC4.2V		DC4.2V	20W	800lm	4.2V 2200mAh	26x2.7x18.5cm
PS-FL-LED078-30W	DC8.4V		DC8.4V		DC8.4V	30W	1200lm	8.4V 5200mAh	30.2x2.8x18.5cm
PS-FL-LED078-50W	DC12.6V		DC12.6V		DC12.6V	50W	2000lm	12.6V 7800mAh	34.3x3x19.5cm

- Material: Aluminium Die-casting body, PC reflector, Tempered glass
- Current output: 1A

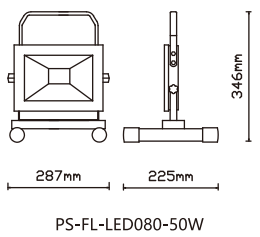
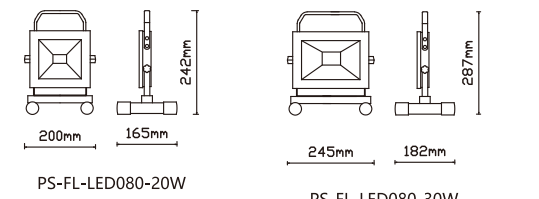

Item No.	Input Voltage	Mains Charger		Car Charger		Power	Luminous Flux	Battery Capacity	Meas
		Input	Output	Input	Output				
PS-FL-LED080-10W	DC4.2V	100V - 240V	DC4.2V	DC12/24V	DC4.2V	10W	400lm	4.2V 2200mAh	14.4x16.2x20cm
PS-FL-LED080-20W	DC4.2V		DC4.2V		DC4.2V	20W	800lm	4.2V 2200mAh	21.5x18.2x24.2cm
PS-FL-LED080-30W	DC8.4V		DC8.4V		DC8.4V	30W	1200lm	8.4V 5200mAh	24.6x19.2x28.7cm
PS-FL-LED080-50W	DC12.6V		DC12.6V		DC12.6V	50W	2000lm	12.6V 7800mAh	27.2x22.3x33.6cm

# LED BULB

## Standard LED Bulbs



Item No.	Input voltage	Lampholder	Type	LED	Power	Luminous Flux	CRI	Material (diffuser/base)
PS-A50-005-5W	AC220-240V	E27/B22	A50	10×SMD5730	5W	396lm	>80	PC/Plastic coated aluminum
PS-A55-005-7W			A55	14×SMD5730	7W	470lm		
PS-A60-005-9W			A60	18×SMD5730	9W	720lm		
PS-A60-005-12W			A60	24×SMD5730	12W	950lm		
PS-A65-005-15W			A65	30×SMD5730	15W	1350lm		

## LED Dusk-to-dawn Bulb



Item No.	Input voltage	Lampholder	Type	LED	Power	Luminous Flux	CRI	Material (diffuser/base)
PS-PLB52LUX-3W	AC95-265V	E27/B22	A60	3×SMD5730	3W	195lm	>80	PC/Plastic coated aluminum
PS-PLB52LUX-5W				5×SMD5730	5W	330lm		
PS-PLB52LUX-7W				7×SMD5730	7W	460lm		
PS-PLB52LUX-9W				9×SMD5730	9W	590lm		
PS-PLB52LUX-12W				12×SMD5730	12W	780lm		

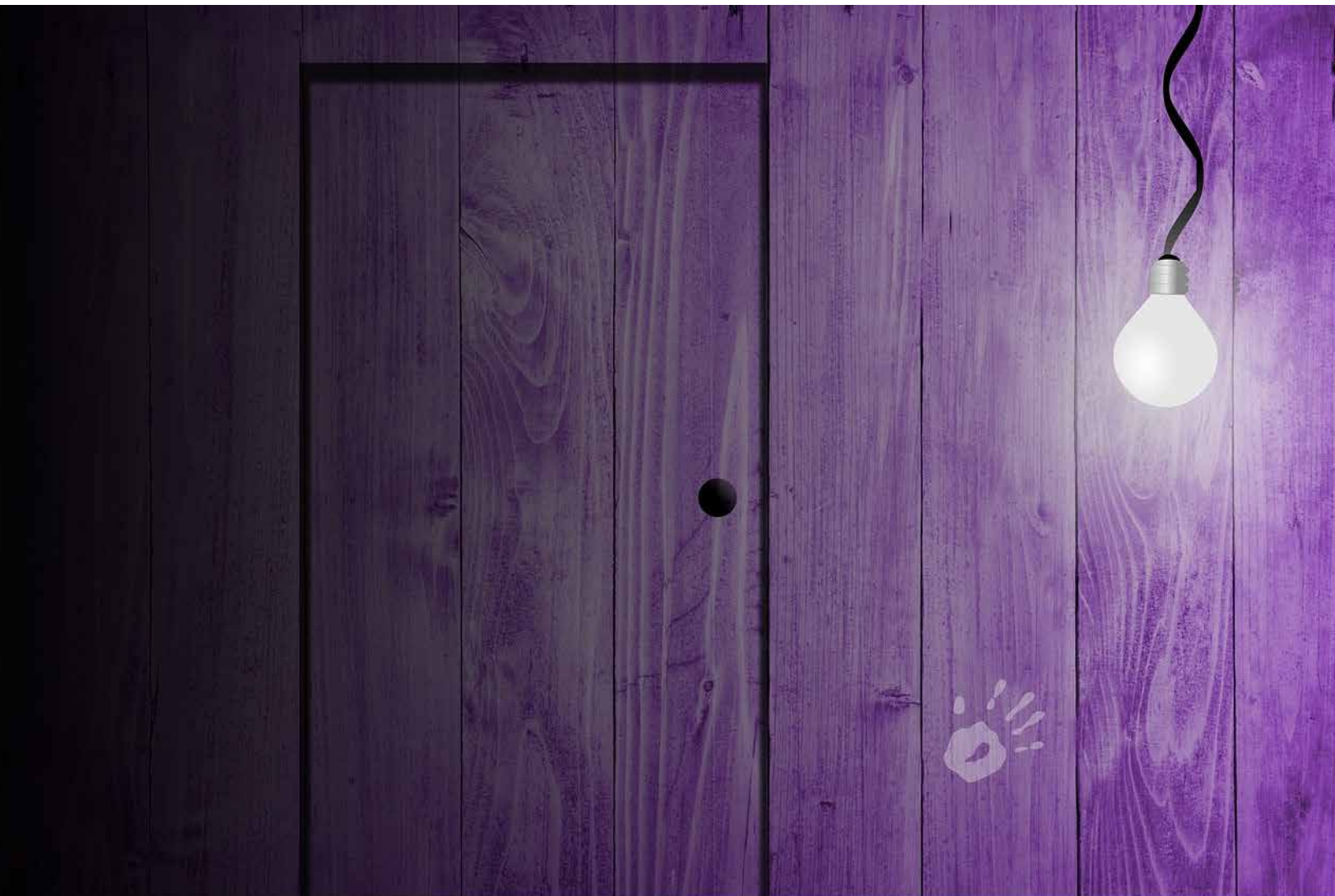

LED Bulb with Microwave Motion Sensor & Dusk-to-dawn 2-in-1

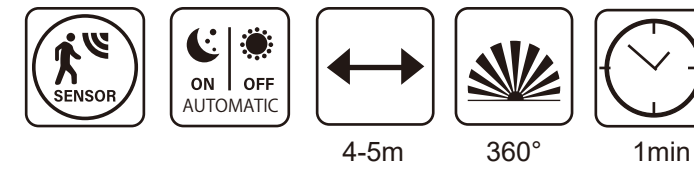

- The bulbs turn on only when the ambient lux is in sufficient and has motion detection
- Press the switch twice to turn off the sensor function
- Nightlight function for option

Item No.	Input voltage	Lampholder	Type	LED	Power	Luminous Flux	CRI	Material (diffuser/base)
PS-PLB03RS-10W	AC220-240V	E27/B22	A65	70xSMD2835	10W	800lm	>80	PC/Plastic coated aluminum



Item No.	Input voltage	Lampholder	Power	Luminous Flux	CRI	Material (diffuser/base)
PS-ST64-4W	AC220-240V	E27	4W	410lm	>80	Glass
PS-ST64-7W			7W	720lm		



Item No.	Input voltage	Lampholder	Power	Luminous Flux	CRI	Material (diffuser/base)
PS-G95-4W	AC220-240V	E27	4W	410lm	>80	Glass
PS-G95-7W			7W	720lm		



Item No.	Input voltage	Lampholder	Power	Luminous Flux	LED	CRI	Material (diffuser/base)
PS-GU5.3-3.5W	AC170-260V	GU5.3	3.5W	410lm	7×SMD2835	>80	PC/ Aluminum
PS-GU5.3-5W	12V AC/DC		5W	720lm	7×SMD2835		



PS-GU10-2835-3W

Item No.	Input voltage	Lampholder	LED	Power	Luminous Flux	CRI	Material (diffuser/base)
PS-GU10-2835-3W	AC220-240V	GU10	15×SMD2835	3W	210lm	>80	PC/ Aluminum
PS-PLB53LUX-3W	AC85-265V	GU10		3W	210lm	>80	PC/ Aluminum

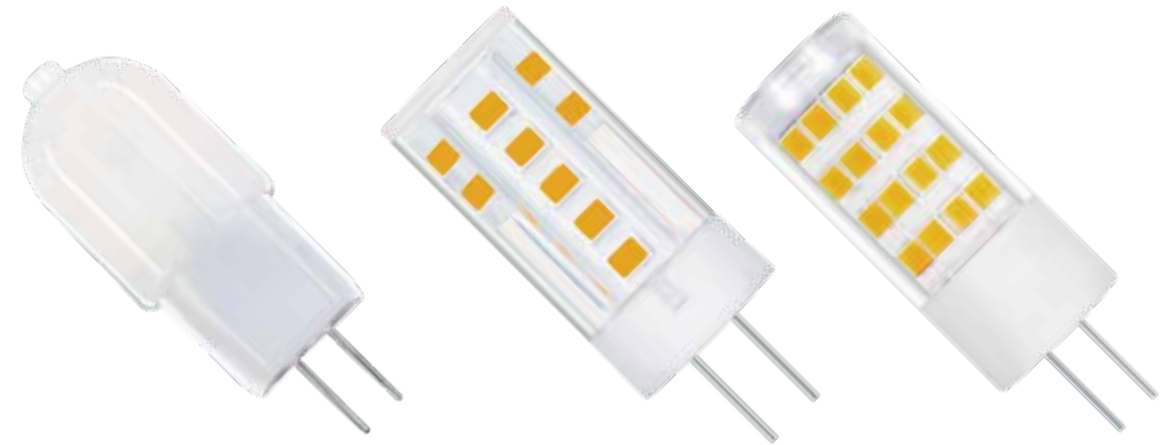

PS-G4-1.8W  
PS-G4-2.3W

PS-G4-2.5W

PS-G4-3.5W  
PS-G4-4W

Item No.	Input voltage	Lampholder	LED	Power	Luminous Flux	CRI	Material (diffuser/base)
PS-G4-1.8W	AC/DC 12V	G4	14×SMD2835	1.8W	160lm	>80	PC
PS-G4-2.3W	AC220-240V		14×SMD2835	2.3W	200lm		PC
PS-G4-2.5W	AC/DC 12V		33×SMD2835	2.5W	270lm		ceramic base with PC diffuser
PS-G4-3.5W	AC/DC 12V		51×SMD2835	3.5W	380lm		ceramic base with PC diffuser
PS-G4-4W	AC220-240V		51×SMD2835	4W	390lm		ceramic base with PC diffuser



PS-G9COB-5W

PS-G9SL-3.8W

PS-G9SL-4.5W

PS-G9T-3.5W

PS-G9T-4W

Item No.	Input voltage	Lampholder	LED	Power	Luminous Flux	CRI	Material (diffuser/base)
PS-G9COB-5W	AC220-240V	G9	1×COB	5W	600lm	>80	PC
PS-G9SL-3.8W	AC220-240V		28×SMD2835	3.8W	360lm		PC
PS-G9SL-4.5W	AC220-240V		22×SMD2835	4.5W	400lm		PC
PS-G9T-3.5W	AC220-240V		45×SMD2835	3.5W	350lm		PC
PS-G9T-4W	AC220-240V		32×SMD4014	4W	380lm		PC

# LED TRI-PROOF LIGHT

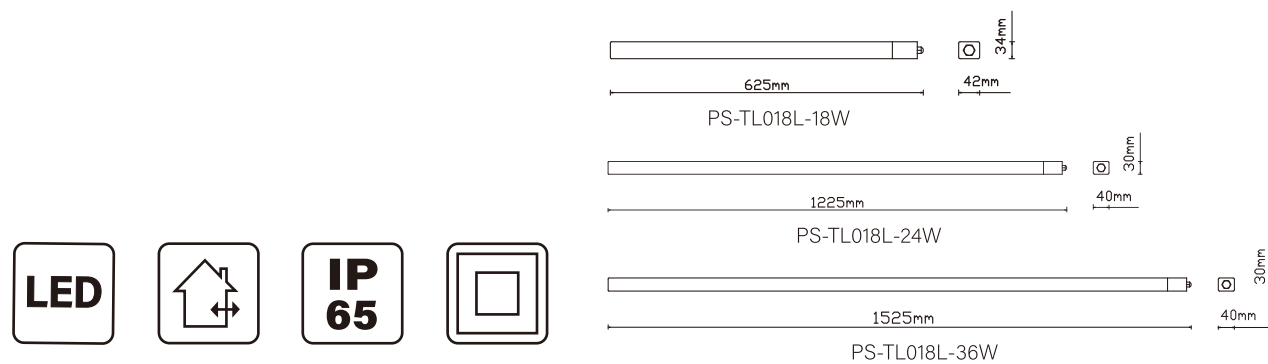

Item No.	Power	Luminous Flux	Material	LED	Meas
PS-TL018L-18W	18W	1900lm	Nano Plastic	90 × SMD2835	625×42×34mm
PS-TL018L-24W	24W	2500lm		120 × SMD2835	1225×40×30mm
PS-TL018L-36W	36W	3800lm		180 × SMD2835	1225×40×30mm



Item No.	Power	Luminous Flux	Material	LED	Meas
PS-TL019L-18W	18W	1900lm	Nano Plastic	90 × SMD2835	625×53×41mm
PS-TL019L-24W	24W	2500lm		120 × SMD2835	1225×53×41mm
PS-TL019L-36W	36W	3800lm		180 × SMD2835	1225×53×41mm

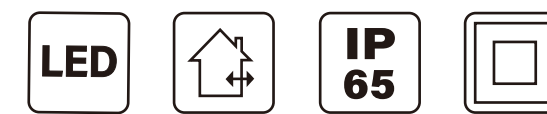
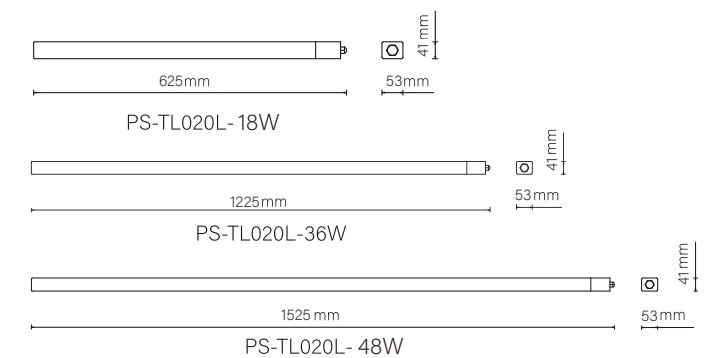

Item No.	Function	Power	Luminous Flux	Material	LED	Meas	
PS-TL020L-18W	ON/OFF	18W	2000lm	PC	90 × SMD2835	625×53×41 mm	
PS-TL020L-36W		36W	4100 lm		120 × SMD2835	1225×53×41 mm	
PS-TL020L-48W		48W	5500 lm		180 × SMD2835	1525×53×41 mm	
PS-TL020L-18W-CCT	CCT 3000-4000-6500K	18W	2000lm	PC	90 × SMD2835	625×53×41 mm	
PS-TL020L-36W-CCT		36W	4100 lm		120 × SMD2835	1225×53×41 mm	
PS-TL020L-48W-CCT		48W	5500lm		180 × SMD2835	1525×53×41 mm	
PS-TL020L-18W-LK	Linkable	upto 12 tubes	18W	PC	90 × SMD2835	625×53×41 mm	
PS-TL020L-36W-LK		upto 8 tubes	36W		4100 lm	120 × SMD2835	1225×53×41 mm
PS-TL020L-48W-LK		upto 6 tubes	48W		5500 lm	180 × SMD2835	1525×53×41 mm



PS-DL-LED083 series



PS-DL-LED084



Item No.	Voltage	Function	Power	Luminous Flux	Material	LED	Meas	Cut Size	IP Rating
PS-DL-LED083-3W	85-265V/AC	ON/OFF	3W	300lm	ABS	6×SMD5730	Φ75×40.3mm	Φ55mm	IP20
PS-DL-LED083-5W			5W	500lm		10×SMD5730	Φ91×45.7mm	Φ75mm	
PS-DL-LED083-7W			7W	700lm		14×SMD5730	Φ91×45.7mm	Φ75mm	
PS-DL-LED083-9W			9W	900lm		18×SMD5730	Φ112×50.7mm	Φ90mm	
PS-DL-LED083-12W			12W	1200lm		24×SMD5730	Φ133×55.7mm	Φ115mm	
PS-DL-LED084-3W	85-265V/AC	ON/OFF	3W	300lm	ABS	6×SMD5730	75×75×40.3mm	Φ55×55mm	IP20
PS-DL-LED084-5W			5W	500lm		10×SMD5730	91×91×45.7mm	Φ75×75mm	
PS-DL-LED084-7W			7W	700lm		14×SMD5730	91×91×45.7mm	Φ75×75mm	
PS-DL-LED084-9W			9W	900lm		18×SMD5730	112×112×50.7mm	Φ90×90mm	
PS-DL-LED084-12W			12W	1200lm		24×SMD5730	133×133×55.7mm	Φ115×115mm	

Item No.	Voltage	Function	Power	Luminous Flux	Material	LED	Meas	Cut Size	IP Rating
PS-DL-LED010-5W	170-260V/AC	ON/OFF	5W	450lm	PC body+ Aluminum radiator	COB	Φ88×75mm	Φ75-82mm	IP20
PS-DL-LED010-7W			7W	630lm					
PS-DL-LED010-5W-DCT	170-260V/AC		5W	450lm	PC body+ Aluminum radiator	COB	Φ88×75mm	Φ75-82mm	IP20
PS-DL-LED010-7W-DCT			7W	630lm					



PS-DL-LED092 series



PS-DL-LED093 series



Item No.	Voltage	Function	Power	Luminous Flux	Material	LED	Meas	Cut Size	IP Rating
PS-DL-LED092-5W	170-260V/AC	ON/OFF	5W	450lm	PC+PS	10×SMD5730	Φ95×26mm	Φ75-90mm	IP20/IP54
PS-DL-LED092-9W			9W	810lm		18×SMD5730	Φ120×26mm	Φ100-115mm	
PS-DL-LED092-12W			12W	1080lm		24×SMD5730	Φ145×26mm	Φ125-140mm	
PS-DL-LED092-18W			18W	1620lm		36×SMD5730	Φ170×26mm	Φ150-165mm	
PS-DL-LED092-24W			24W	2160lm		48×SMD5730	Φ225×26mm	Φ205-220mm	
PS-DL-LED092-5W-DCT	170-260V/AC		5W	450lm	PC+PS	10×SMD5730	Φ95×26mm	Φ75-90mm	IP20/IP54
PS-DL-LED092-9W-DCT			9W	810lm		18×SMD5730	Φ120×26mm	Φ100-115mm	
PS-DL-LED092-12W-DCT			12W	1080lm		24×SMD5730	Φ145×26mm	Φ125-140mm	
PS-DL-LED092-18W-DCT			18W	1620lm		36×SMD5730	Φ170×26mm	Φ150-165mm	
PS-DL-LED092-24W-DCT			24W	2160lm		48×SMD5730	Φ225×26mm	Φ205-220mm	
PS-DL-LED093-5W	170-260V/AC	ON/OFF	5W	450lm	PC+PS	10×SMD5730	95×95×26mm	Φ75-90mm	IP20/IP54
PS-DL-LED093-9W			9W	810lm		18×SMD5730	120×120×26mm	Φ100-115mm	
PS-DL-LED093-12W			12W	1080lm		24×SMD5730	145×145×26mm	Φ125-140mm	
PS-DL-LED093-18W			18W	1620lm		36×SMD5730	170×170×26mm	Φ150-165mm	
PS-DL-LED093-24W			24W	2160lm		48×SMD5730	225×225×26mm	Φ205-220mm	
PS-DL-LED093-5W-DCT	170-260V/AC		5W	450lm	PC+PS	10×SMD5730	95×95×26mm	Φ75-90mm	IP20/IP54
PS-DL-LED093-9W-DCT			9W	810lm		18×SMD5730	120×120×26mm	Φ100-115mm	
PS-DL-LED093-12W-DCT			12W	1080lm		24×SMD5730	145×145×26mm	Φ125-140mm	
PS-DL-LED093-18W-DCT			18W	1620lm		36×SMD5730	170×170×26mm	Φ150-165mm	
PS-DL-LED093-24W-DCT			24W	2160lm		48×SMD5730	225×225×26mm	Φ205-220mm	

Item No.	Voltage	Function	Power	Luminous Flux	Material	LED	Meas	Cut Size	IP Rating
PS-DL-LED090-8W-DCT	220-240V/AC		8W	640lm	Flat face PBT +aluminium	20×SMD2835	Φ95×50mm	Φ70mm	IP44
PS-DL-LED090-10W-DCT			10W	800lm		20×SMD2835	Φ113×57mm	Φ90mm	
PS-DL-LED090-14W-DCT			14W	1120lm		28×SMD2835	Φ145×65mm	Φ120mm	



# LED DOWN LIGHT AND LED PANEL LIGHT



**Posa**

Light, since 2007



PS-DL-R04 series



PS-DL-R04 series



PS-DL-R01 series

Item No.	Voltage	Function	Power	Luminous Flux	Material	LED	Meas	Cut Size	IP Rating
PS-DL-R04-3W	85-265V/AC	ON/OFF	3W	240lm	Aluminium +PS	15xSMD2835	Φ85x13mm	Φ75mm	IP20
PS-DL-R04-6W			6W	480lm		30xSMD2835	Φ120x13mm	Φ105mm	
PS-DL-R04-9W			9W	720lm		45xSMD2835	Φ145x13mm	Φ135mm	
PS-DL-R04-12W			12W	960lm		60xSMD2835	Φ170x13mm	Φ160mm	
PS-DL-R04-15W			15W	1200lm		75xSMD2835	Φ190x13mm	Φ180mm	
PS-DL-R04-18W			18W	1440lm		90xSMD2835	Φ225x13mm	Φ205mm	
PS-DL-R04-24W			24W	1920lm		120xSMD2835	Φ300x13mm	Φ280mm	
PS-DL-R01-6W	85-265V/AC	ON/OFF	6W	480lm	Aluminium +PS	30xSMD2835	Φ120x35mm	×	IP20
PS-DL-R01-12W			12W	960lm		60xSMD2835	Φ170x35mm		
PS-DL-R01-18W			18W	1440lm		90xSMD2835	Φ225x35mm		
PS-DL-R01-24W			24W	1920lm		120xSMD2835	Φ300x35mm		



PS-DL-S04 series



PS-DL-S01 series

Item No.	Voltage	Function	Power	Luminous Flux	Material	LED	Meas	Cut Size	IP Rating
PS-DL-S04-3W	85-265V/AC	ON/OFF	3W	240lm	Aluminium +PS	15xSMD2835	85x85x13mm	75x75mm	IP20
PS-DL-S04-6W			6W	480lm		30xSMD2835	120x120x13mm	105x105mm	
PS-DL-S04-9W			9W	720lm		45xSMD2835	145x145x13mm	135x135mm	
PS-DL-S04-12W			12W	960lm		60xSMD2835	170x170x13mm	160x160mm	
PS-DL-S04-15W			15W	1200lm		75xSMD2835	190x190x13mm	180x180mm	
PS-DL-S04-18W			18W	1440lm		90xSMD2835	225x225x13mm	205x205mm	
PS-DL-S04-24W			24W	1920lm		120xSMD2835	300x300x13mm	280x280mm	
PS-DL-S01-6W	85-265V/AC	ON/OFF	6W	480lm	Aluminium +PS	30xSMD2835	120x120x35mm	×	IP20
PS-DL-S01-12W			12W	960lm		60xSMD2835	170x170x35mm		
PS-DL-S01-18W			18W	1440lm		90xSMD2835	225x225x35mm		
PS-DL-S01-24W			24W	1920lm		120xSMD2835	300x300x35mm		

# LED PANEL LIGHT



**Posa**

Light, since 2007



PS-DL6030 series



PS-DL1230 series



PS-DL6060 series

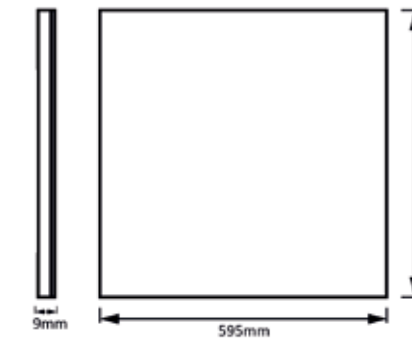

- Emergency for option
- Dimming for option

Item No.	Input Voltage	LED	Power	Luminous Flux	Ra	Material	IP Rating	Meas
PS-DL3030-10W	110-130V/AC 220-240V/AC 85-265V/AC	100×SMD3014	10W	800lm	80	Aluminium frame, PS diffuser	IP20	300×300×12.5mm
PS-DL3030-18W		180×SMD3014	18W	1440lm				300×300×9.5mm
PS-DL6030-18W		180×SMD3014	18W	1440lm				300×600×9.5mm
PS-DL6030-24W		240×SMD3014	24W	1920lm				300×600×9.5mm
PS-DL6030-30W		300×SMD3014	30W	2400lm				300×600×9.5mm
PS-DL6060-36W		192×SMD4014	36W	2880lm				595×595×9mm
PS-DL6060-48W		240×SMD4014	48W	4320lm				595×595×9mm
PS-DL6060-60W		324×SMD4014	60W	4800lm				595×595×9mm
PS-DL1230-36W		360×SMD3014	36W	2880lm				300×1200×9.5mm
PS-DL1230-48W		480×SMD3014	48W	3840lm				300×1200×9.5mm
PS-DL1230-60W		600×SMD3014	60W	4800lm				300×1200×9.5mm
PS-DL1260-48W		480×SMD3014	48W	3840lm				600×1200×9.5mm
PS-DL1260-60W		600×SMD3014	60W	4800lm				600×1200×9.5mm
PS-DL1260-72W		360×SMD2835	72W	7200lm				595×1195×30mm
PS-DL1260-90W		900×SMD3014	90W	8100lm				600×1200×9.5mm



# MICROWAVE MOTION SENSOR

- Human Body Induction
- Time Delay
- High Light Efficiency
- Easy Installation



## Microwave Motion Sensor

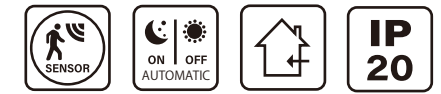

Internal microwave sensor, knob adjustable

- Input voltage: 220V-240V/AC, 110-130V/AC
- Detection angle : 180° × 360° (horizontal, vertical)
- Hold on time: 8sec-12min, adjustable
- Response brightness adjustable from dark to daylight
- Max. range approx. : 10meter, radii., adjustable
- Max. loading for LED: 200W LED

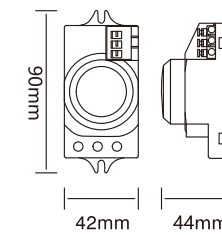

PS-RS02

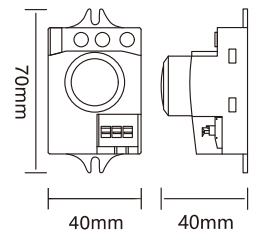

PS-RS02S

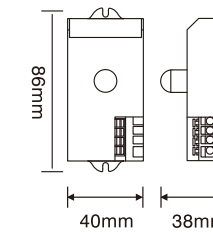

PS-RS09

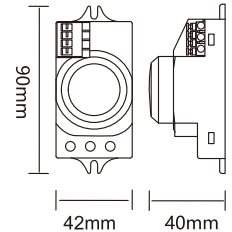

PS-RS19

- Input voltage: 220V-240V/AC, 110-130V/AC
- Detection angle : 180° × 360° (horizontal, vertical)
- Hold on time: 8sec-12min, adjustable

Surface mounted microwave sensor outdoor , IP65

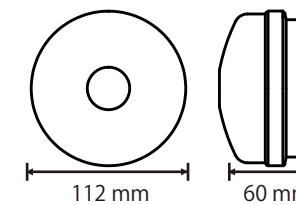

PS-RS08A

- Response brightness adjustable from dark to daylight
- Max. range approx. : 10meter, radii., adjustable
- Max. loading for LED: 200W LED

Surface mounted microwave sensor

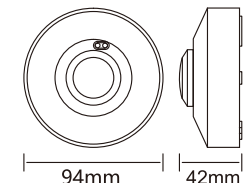

PS-RS01



PS-RS02A-1

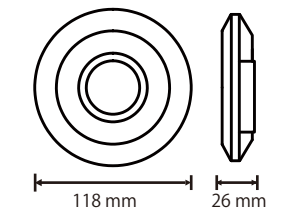

PS-RS68



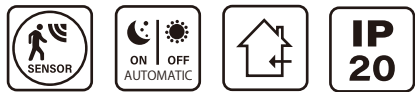

Internal microwave sensor, DIP adjustable

- Input voltage: 220V-240V/AC, 110-130V/AC
- Detection angle : 180° × 360° (horizontal, vertical)
- Hold on time: 10sec-30min, adjustable
- Response brightness adjustable from dark to daylight
- Max. range approx. : 10meter, radii., adjustable
- Max. loading for LED: 200W LED



PS-RS13



PS-RS18

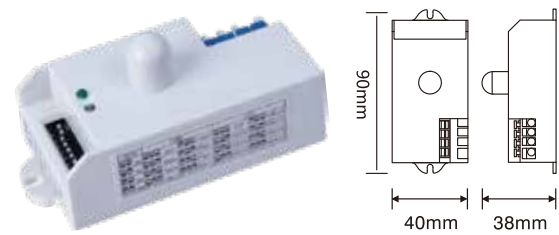

PS-RS12



PS-RS08

Recessed flush mounted microwave sensor

- Input voltage: 220V-240V/AC, 110-130V/AC
- Detection angle : 180° × 360° (horizontal, vertical)
- Max. range approx. : 10meter, radii., adjustable
- Hold on time: 10sec-30min, adjustable
- Response brightness adjustable from dark to daylight
- Max. loading for LED: 200W LED



PS-RS16

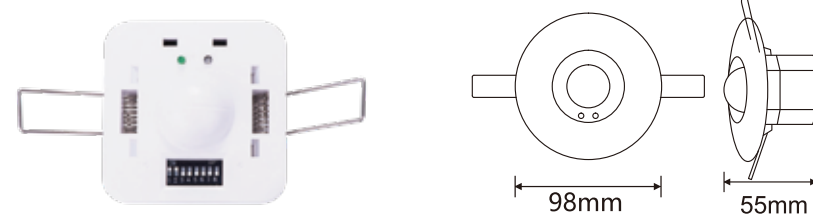

Recessed flush mounted microwave sensor

- Input voltage: 220V-240V/AC, 110-130V/AC
- Detection angle : 180° × 360° (horizontal, vertical)
- Max. range approx. : 8meter, radii., adjustable
- Hold on time: 10sec-12min, adjustable
- Response brightness adjustable from dark to daylight
- Max. loading for LED: 200W LED



PS-RS41

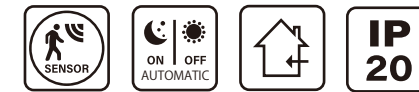
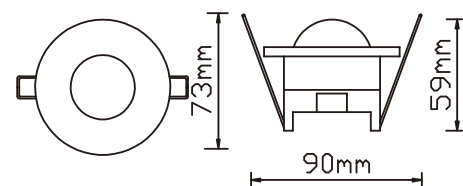

Internal microwave sensor, DIP adjustable

- Input voltage: 90V-250V/AC
- Detection angle : 180° × 360° (horizontal, vertical)
- Hold on time: 6sec-15min, adjustable



PS-RS06

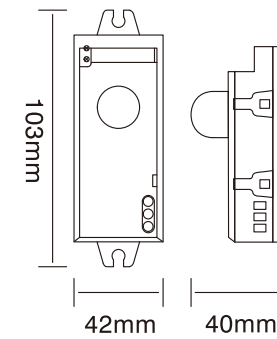

Internal microwave sensor, DIP adjustable

- Input voltage: 220V-240V/AC, 110-130V/AC
- Detection angle : 180° × 360° (horizontal, vertical)
- Hold on time: 10sec-12min, adjustable
- Response brightness adjustable from dark to daylight
- Max. range approx. : 10meter, radii., adjustable
- Max. loading for LED: 200W LED

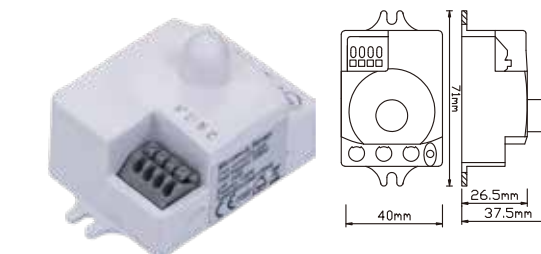

PS-RS31

Internal microwave sensor, DIP adjustable

- Input voltage: 220V-240V/AC
- Detection angle : 180° × 360° (horizontal, vertical)
- Hold on time: 5sec-10min, adjustable
- Response brightness adjustable from dark to daylight
- Max. range approx. : 10meter, radii., adjustable
- Max. loading for LED: 200W LED



PS-RS45

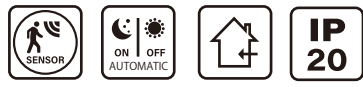

Internal microwave sensor, DIP adjustable

- Input voltage: 220V-240V/AC, 110-130V/AC
- Detection angle : 180° × 360° (horizontal, vertical)
- Hold on time: 8sec-12min, adjustable
- Response brightness adjustable from dark to daylight
- Max. range approx. : 8meter, radii., adjustable



PS-RS46

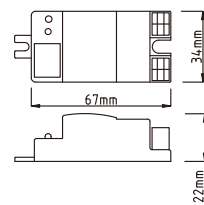

PS-RS24

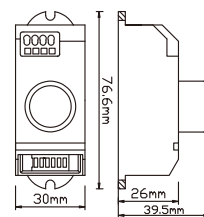

Internal microwave sensor, DIP adjustable

- Input voltage: 220V-240V/AC, 110-130V/AC
- Detection angle : 180° × 360° (horizontal, vertical)
- Hold on time: 5sec-3min, adjustable
- Response brightness adjustable from dark to daylight
- Max. range approx. : 8meter, radii., adjustable
- Max. loading for LED: 200W LED



PS-RS65

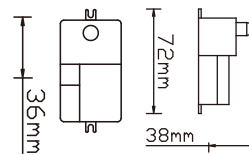

Internal microwave sensor, DIP adjustable

- Input voltage: 100V-240V/AC
- Detection angle : 180° × 360° (horizontal, vertical)
- Hold on time: 15sec-10min, adjustable
- Response brightness adjustable from dark to daylight
- Max. range approx. : 14meter, radii., adjustable
- Max. loading for LED: 200W LED



PS-RS66

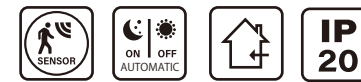
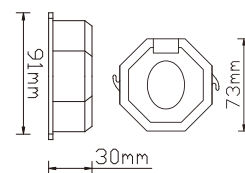

Microwave sensor lampholder, E27

- Input voltage: 90V-230V/AC
- Detection angle : 180° × 360° (horizontal, vertical)
- Hold on time: 5sec-8min, adjustable
- Response brightness adjustable from dark to daylight
- Max. range approx. : 8meter, radii., adjustable
- Max. loading for LED: 200W LED



PS-RS67

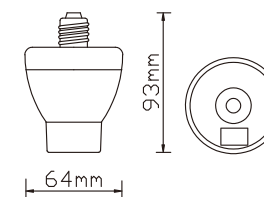

2-in-1 Microwave sensor for ultraviolet disinfection mode and normal sensor mode

- Input voltage: 12V-36V/DC
- Detection angle : 180° × 360° (horizontal, vertical)
- Hold on time: 10sec-12min, adjustable
- Response brightness adjustable from dark to daylight
- Max. range approx. : 10meter, radii., adjustable
- Max. loading for LED: 300W LED
- Ultraviolet disinfection mode setting:  
Hold time for without Ultraviolet disinfection: 10sec / 1min / 3min / 5min  
● Hold time for Ultraviolet disinfection: 10min / 30min / 60min / 24H
- Max. range approx.: 10meter, radii., adjustable



PS-RS08S

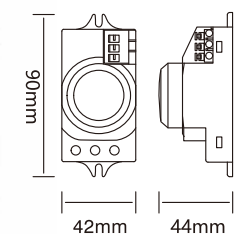

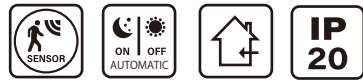

Microwave sensor with nightlight function

- Input voltage: 220V-240V/AC, 110-130V/AC
- Detection angle : 180° × 360° (horizontal, vertical)
- Hold on time: 12sec-30min, adjustable
- Response brightness adjustable from dark to daylight
- Max. range approx. : 10meter, radii., adjustable
- Max. loading for LED: 300W LED
- Semi-brightness hold time: stay on
- Semi-brightness: 10%-60%
- Nightlight hold on time: all night
- Nightlight brightness: 10% -60%



PS-RS08D

Microwave sensor with nightlight function

- Input voltage: 90V-260V/AC
- Detection angle : 180° × 360° (horizontal, vertical)
- Hold on time: 10sec-10min, adjustable
- Response brightness adjustable from dark to daylight
- Max. range approx. : 10meter, radii., adjustable
- Max. loading for LED: 300W LED
- Semi-brightness hold time: 1min-24h
- Semi-brightness: 0%-30%
- Nightlight hold on time: 1min -all night
- Nightlight brightness: 10% -60%

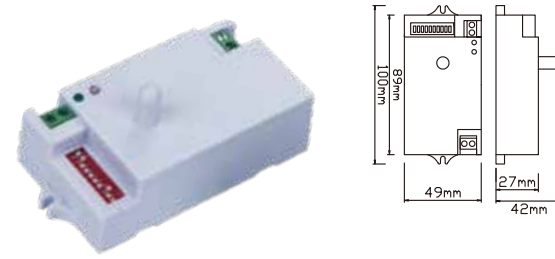

PS-RS34D



Microwave sensor with nightlight function

- Input voltage: 12V-30V/DC, 20-60V/DC
- Detection angle : 180° × 360° (horizontal, vertical)
- Hold on time: 10sec-10min, adjustable
- Response brightness adjustable from dark to daylight
- Max. range approx. : 10meter, radii., adjustable
- Max. loading for LED: 200W LED
- Nightlight hold on time: 1min / 30min / 60min / all night
- Nightlight brightness: switch off/ 10% / 20% / 30%

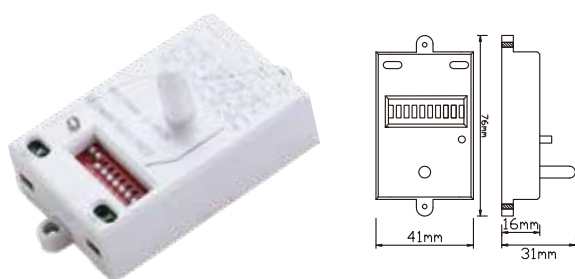

PS-RS27D

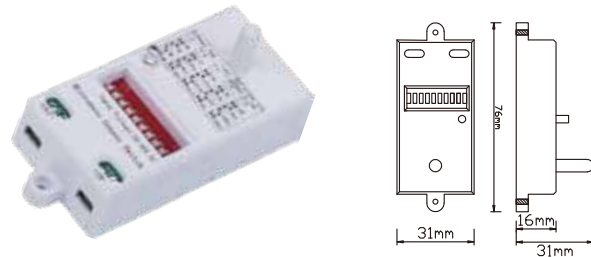

PS-RS27D-1



Microwave sensor with nightlight function

- Input voltage: 25V-80V/DC
- Detection angle : 180° × 360° (horizontal, vertical)
- Hold on time: 10sec-12min, adjustable
- Response brightness adjustable from dark to daylight
- Max. range approx. : 8meter, radii., adjustable
- Max. loading for LED: 200W LED
- Semi-brightness hold time: stay on
- Semi-brightness: 0%-30%
- Nightlight hold on time: all night or switch off
- Nightlight brightness: 0% -30%

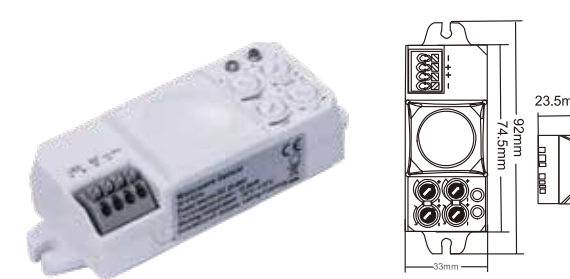

PS-RS28D

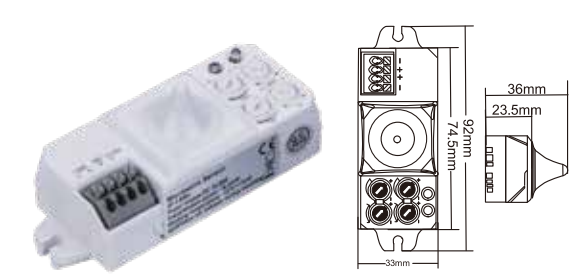

PS-RS29D

PIR motion sensor

- Input voltage: 220V-240V/AC
- Detection angle : 180° × 360° (horizontal, vertical)
- Hold on time: Max 7min, adjustable
- Detect distance: Max 6m
- Response brightness adjustable from dark to daylight
- Max. loading for LED: 200W LED



PS-SS41

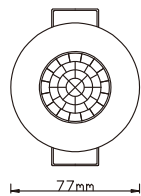
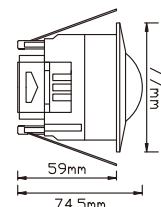

PS-SS49

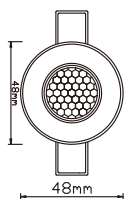
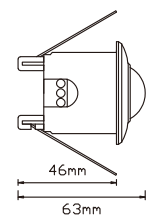

PS-SS29A

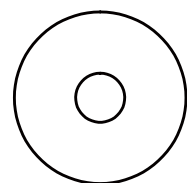

PS-SS8V

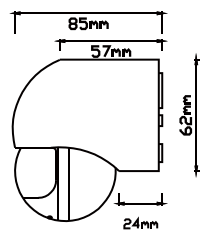
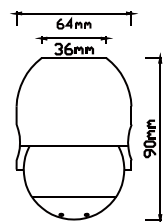

Surface mounted PIR sensor, ultra thin

- Input voltage: 220-240V/AC
- Detection angle : 180° × 360° (horizontal, vertical)
- Hold on time: 10sec-30min, adjustable
- Response brightness adjustable from dark to daylight
- Max. range approx. : 6meter, dia.
- Max. loading for LED: 200W LED



PS-SS82

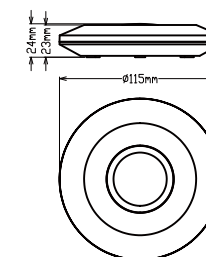

Recessed flush mounted PIR motion sensor

- Input voltage: 220-240V/AC
- Detection angle : 180° × 360° (horizontal, vertical)
- Hold on time: 8sec-7min, adjustable
- Response brightness adjustable from dark to daylight
- Max. range approx. : 5meter, dia.
- Max. loading for LED: 150W LED



PS-SS95B

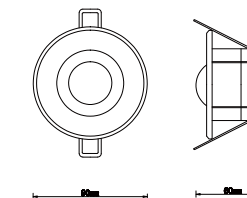

PIR ceiling sensor, surface or flush mounted 2-in-1

- Input voltage: 220-240V/AC
- Detection angle : 180° × 360° (horizontal, vertical)
- Hold on time: 10sec-30min, adjustable
- Response brightness adjustable from dark to daylight
- Max. range approx. : 6meter, dia.
- Max. loading for LED: 200W LED



PS-SS94B

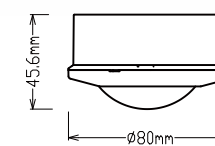

PS-SS94A

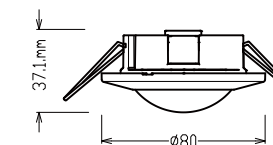

# Dual Detector PIR Motion Sensor Waterproof IP65



Detection Range: 180°/360°  
Detection Distance: max.12m  
IP65



Item No.:PS-SS50

Dual Detecting Range  
IP65 Protect Degree



IP65  
Waterproof

## Perfect waterproof design of junction box

IP  
65



Item NO.: PS-SS50

Wall Mounted: 180°  
Ceiling Mounted: 360°



Downward Detecting Area

Front Detecting Area

Detect Distance: max.12m.(<24°C)



### PIR motion sensor

- Input voltage: 220V-240V/AC
- Detection angle : 180° × 360° (horizontal, vertical)
- Hold on time: Max 15min, adjustable
- Detece distance: max.12m
- Response brightness adjustable from dark to daylight
- Max. loading for LED: 200W LED



PS-SS50

