



PROFESSIONAL MANUFACTURE INTERNATIONAL TRADER  
2019 — 2020

# SENSOR LIGHTS SENSORS

ENERGY-SAVING  
AUTOMATICALLY LIGHTING



2019 — 2020 — PRODUCT CATALOG



NINGBO POSA TECH CO., LTD.

Office Add: No.1108,Jiangnan Rd, Hi-Tech Park, 315040 Ningbo, China

Factory Add: No.15, Jingwu middle rd, Xiaogang, Beilun Zone, 315800 Ningbo, China

Tel: 0086-574-8733 6707 0086-574-8752 9365

Fax: 0086-574-8733 4848

E-mail: info@posa-tech.net

Web: www.posa-tech.net



SCAN AND GET BACKSTAGE

The company reserves the right to change product design, specifications and parameters without prior notice. Please refer to the product specification.  
Printing may make the products in the materials different from the real ones. All the materials are carefully proofread. If there are any printing mistakes, the company will not bear the consequences.

The company reserves the right of final interpretation of the information.

NINGBO POSA TECH CO., LTD.



## ABOUT POSA

PoSa Tech is your reliable partner in China for the professional innovation electronics and lightings, especially sensor related products. The demands on lighting have changed dramatically in recent years. Modern lighting should be energy-efficient while also giving people every convenience. We pursue a smart and eco saver life for the person who uses our products. Until now our engineer has invented wireless linking sensor lights, dimmable sensor light, emergency lights. We can also combine all these function in one light.

In PoSa, 100% products are exported. We pay attention to the quality, customer request and target market's certification. The main customers of our company include Eastern, Western Europe, North, South Africa and Asia.

### The Products

We offer :

- Sensors including microwave motion sensor, PIR motion sensor and photocell sensor.
- LED ceiling/wall lights.
- LED ceiling/wall lights with additional function: standard motion sensor lights, dimmable motion sensor lights, wireless linking & dimmable motion sensor lighting.
- LED ceiling/wall lights with additional function: emergency lights, emergency motion sensor lights, dimmable emergency sensor lights.
- LED tri-proof lights with/without above mentioned functions.

### The Technology

One of the foundations is high quality of the products. Our specialists from the Development Department are constantly working on increasing quality standards. We offer the technical solution before and after sale. To be a qualified supplier for the high-level market, most of PoSa Tech products have CE, ETL, LVD, GS, UL, R&TTE approval. We are RoHS compliant.

We welcome OEM & ODM projects, design and produce tailor to the customer's request. Our goal is growth with our customers.



THANKS FOR TRUST US!

QUALIFICATION & CERTIFICATION





**POSA**

# PRODUCT CATALOG

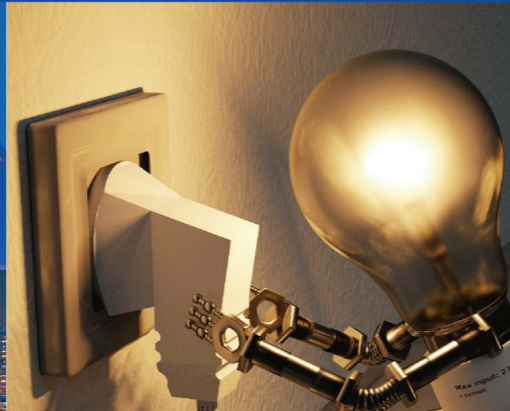

Smart Ceiling Light .....	01
Remote Control Light .....	05
Backlight Type Light .....	09
RF Communication Version .....	11
CCT Adjustable Ceiling Light .....	13
Microwave Motion Sensor Light .....	16

## LED Ceiling Light

Outdoor Lighting .....	17
------------------------	----

## Outdoor Lighting

LED Floodlight .....	23
Work Light .....	29
Rechargeable Work Light .....	30

## LED Floodlight

LED Bulb .....	31
----------------	----

## LED Bulb

LED Tri-proof Tube Light .....	33
--------------------------------	----

## LED Tri-proof Tube Light

Microwave Motion Sensor .....	35
-------------------------------	----

## Microwave Motion Sensor

PIR Motion Sensor .....	45
-------------------------	----

## PIR Motion Sensor

Smart Socket .....	49
--------------------	----

## Smart Socket



# SMART CEILING LIGHT



## Different Color Different Scence

16 million colors for your choice, to meet your needs of creating different scences. Meanwhile, brightness is allowed to change from bright to dark.

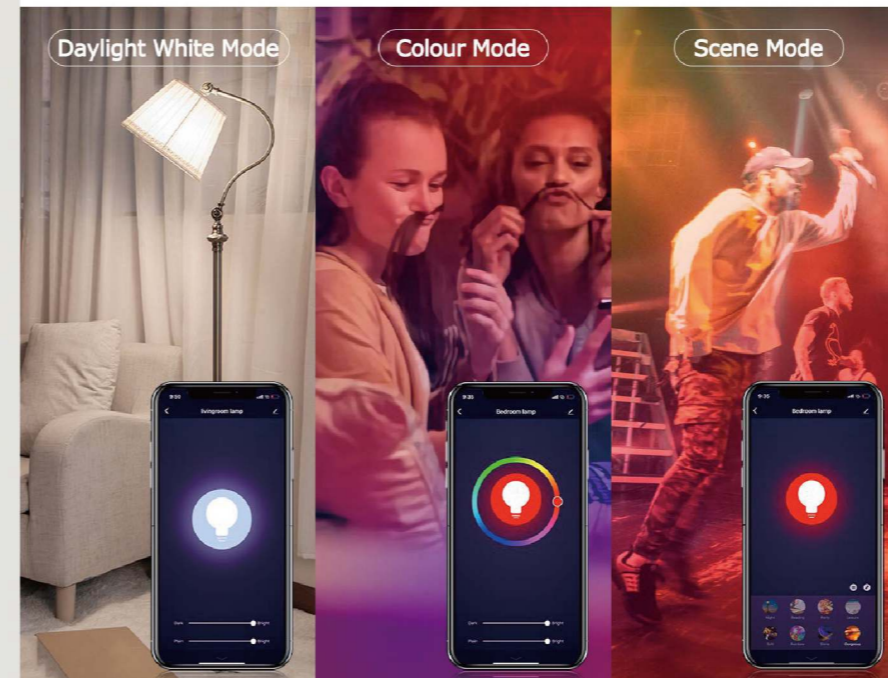

## PS-SL98L-24W-APP

- Voice control, match with Google assistant and Amazon Alexa
- APP turn on/ off
- APP adjust the front light's brightness, CCT
- APP adjust the back light's color
- Colorful housing: ICE Blue/ Pink/ Sky Blue/ Gold
- Material: PC/ PC
- 100-240V AC
- Ra 80
- 100lm/w
- IP20

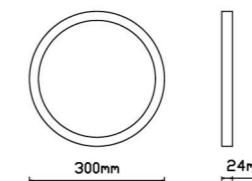

Item No	PS-SL98L-24W-APP
Power	20W+4W
Lumen	0-1920lm
LED	100pcs+20pcs SMD2835
Color temperature	2700K-6500K, adjustable
Meas	dia300×24mm

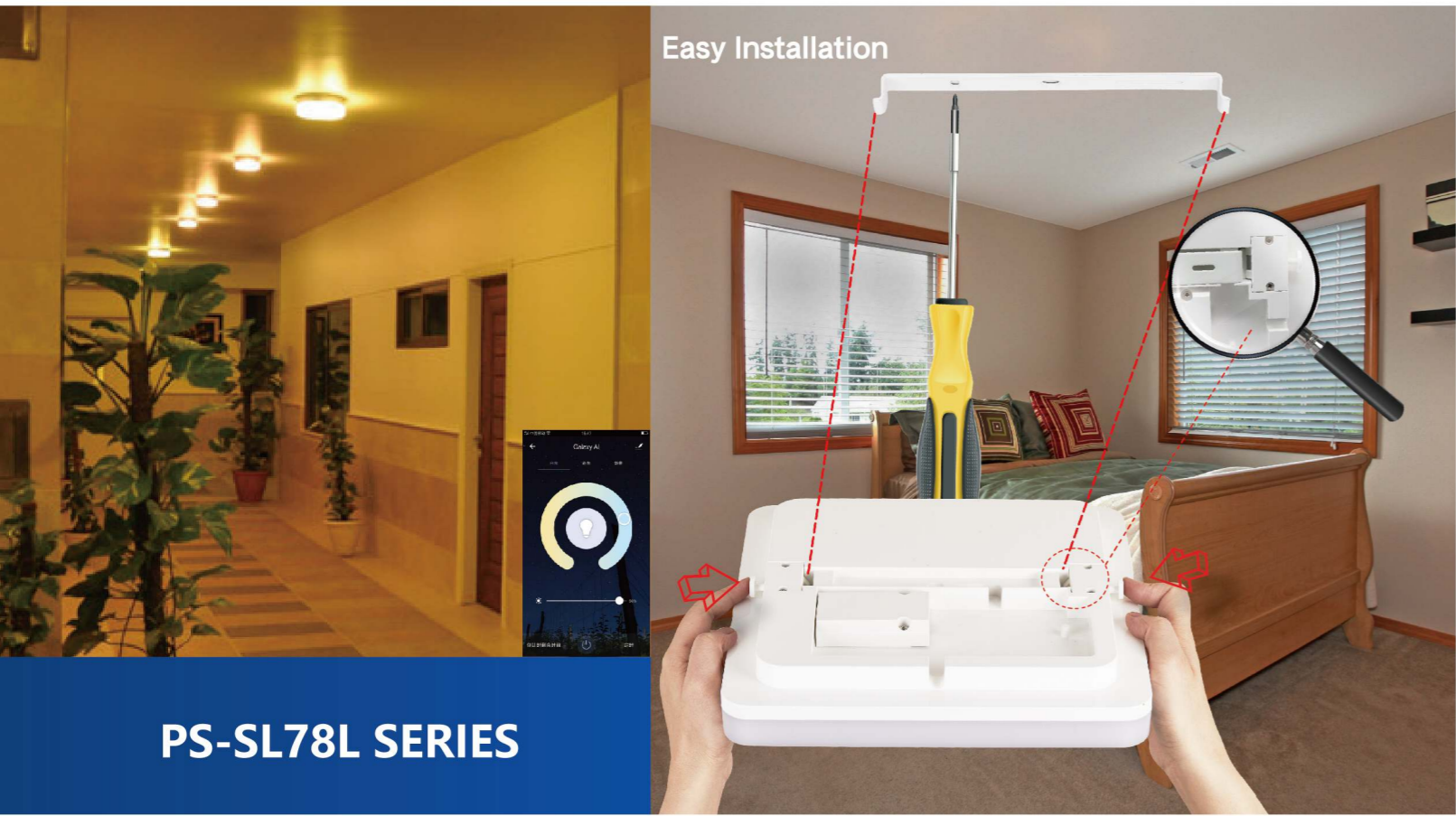

Easy Installation

PS-SL78L SERIES

- Adjust the color temperature
- Adjust the brightness
- Turn on/ off

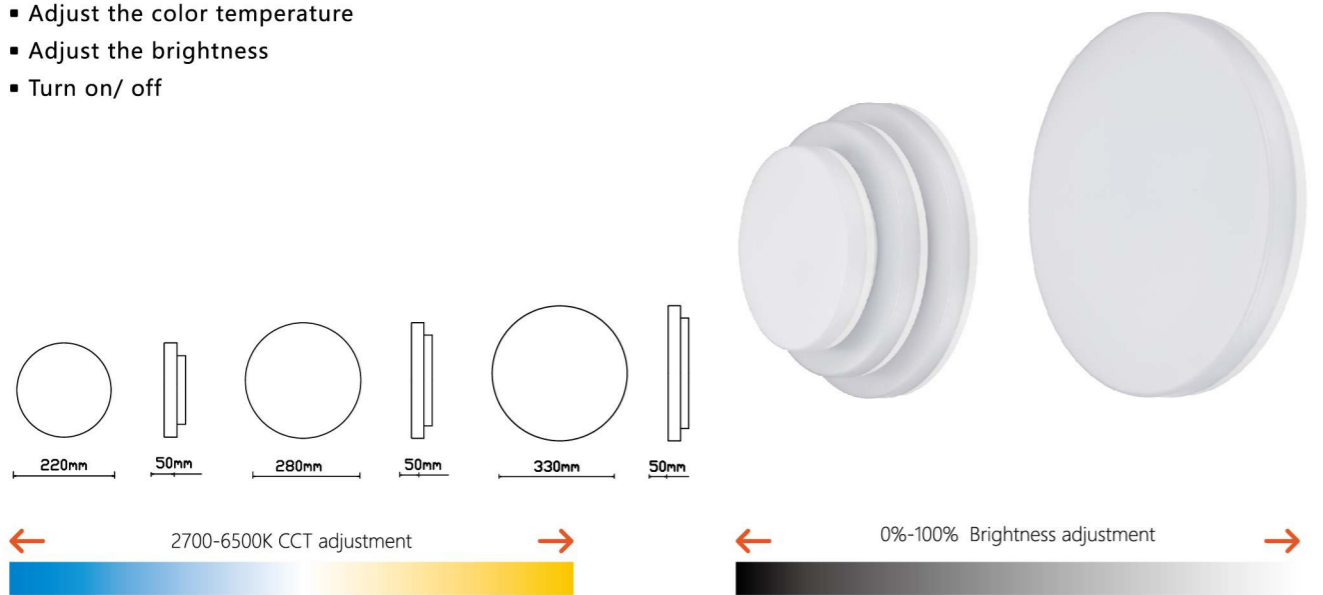

Item No	PS-SL78L-15W-APP	PS-SL78L-18W-APP	PS-SL78L-24W-APP
Power	15W	18W	24W
Lumen	1350lm	1530lm	2000lm
LED	75pcs SMD2835	90pcs SMD2835	120pcs SMD2835
Color temperature	2700K-6500K, adjustable		
Meas	dia.220×50mm	dia.280×50mm	dia.330×50mm

PS-SL79L SERIES

- Adjust the color temperature
- Adjust the brightness
- Turn on/ off

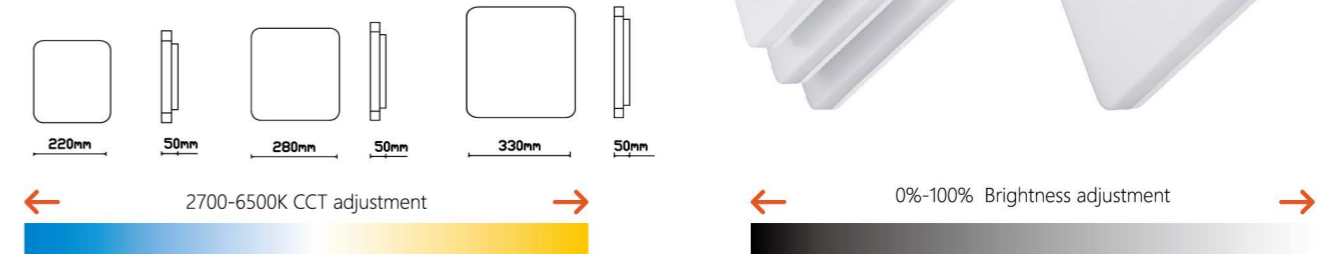

Item No	PS-SL79L-15W-APP	PS-SL79L-18W-APP	PS-SL79L-24W-APP
Power	15W	18W	24W
Lumen	1350lm	1530lm	2000lm
LED	75pcs SMD2835	90pcs SMD2835	120pcs SMD2835
Color temperature	2700K-6500K, adjustable		
Meas.	220×220×50mm	280×280×50mm	330×330×50mm

PS-SL82L-24W-APP

- Adjust the color temperature
- Adjust the brightness
- Turn on/ off

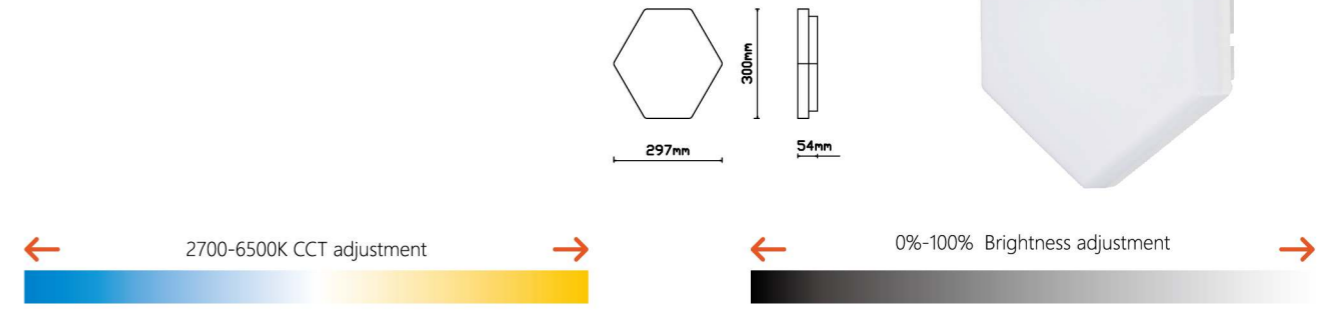

Item No	PS-SL82L-24W-APP
Power	24W
Lumen	2000lm
LED	193pcs SMD2835
Color temperature	2700K-6500K, adjustable
Meas.	300×54mm



# REMOTE CONTROL LIGHT

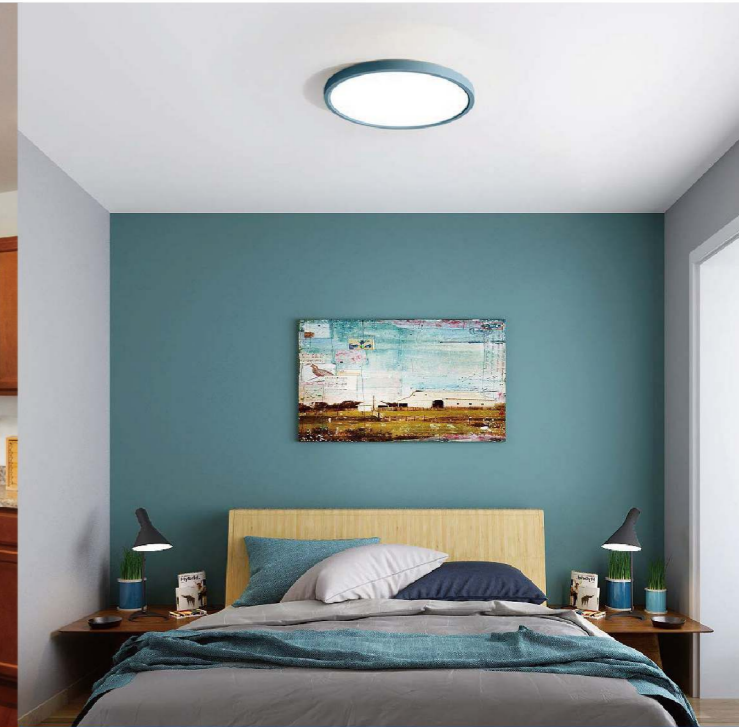
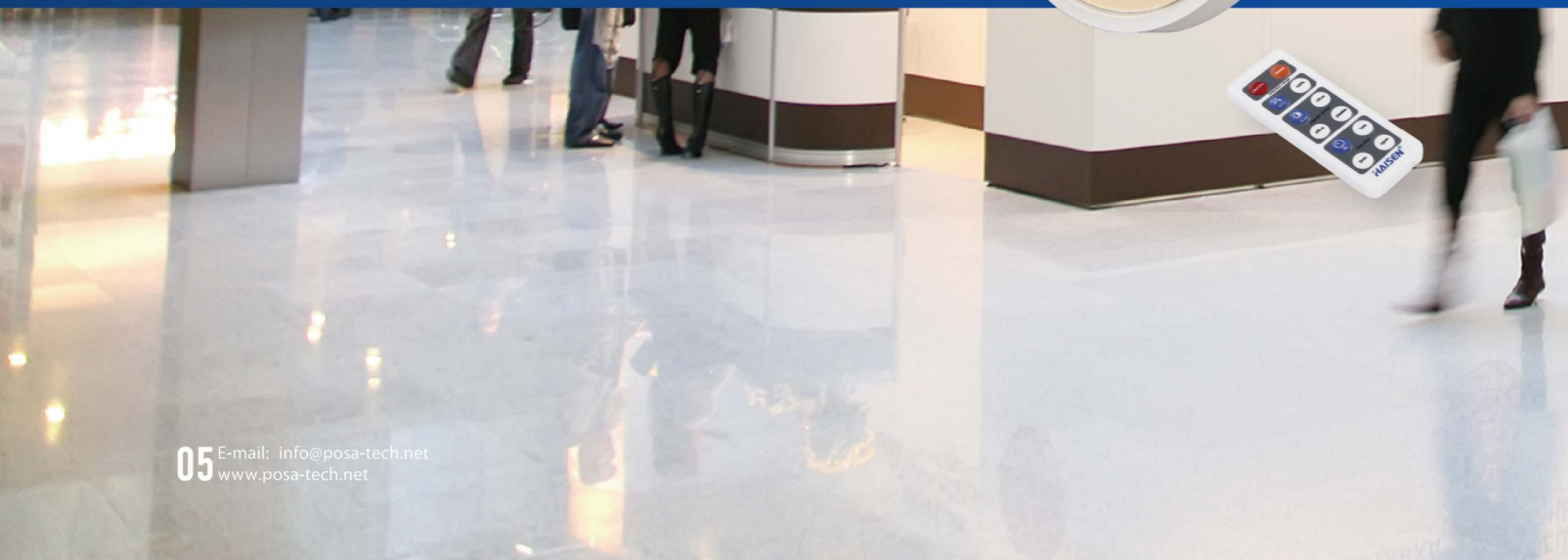

# PS-CL98L SERIES

- Color temperature: 2700K-6500k, CCT adjustment by remote
- Luminous flux: 0-1600lm, brightness adjustment by remote

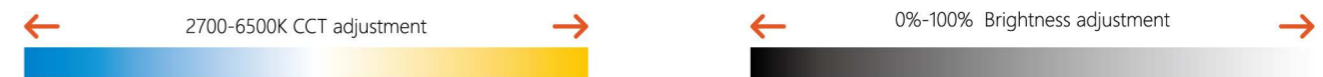
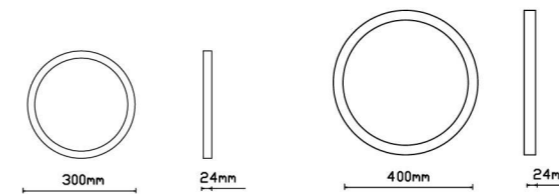

Item No	PS-CL98L-20W-DCT	PS-CL98L-24W-DCT
Power	20W	24W
Lumen	2000lm	2400lm
LED	200pcs SMD2835	240pcs SMD2835
Color temperature	3000/ 4000/ 6000K	
Frame color	white	white
Meas	dia300*24mm	dia400*24mm



## PS-ML78L SERIES

- Material: PC/PC
- 220-240V AC
- Ra 80
- 90lm/w
- IP20
- Remote control
- HF sensor control by remote :
  - Time delay: 5sec, 1min, 5min, 10min
  - Detection range: 5m, 10m
  - Light control: 2Lux, 10Lux, 50Lux, 2000Lux
  - Detection angle: 360°

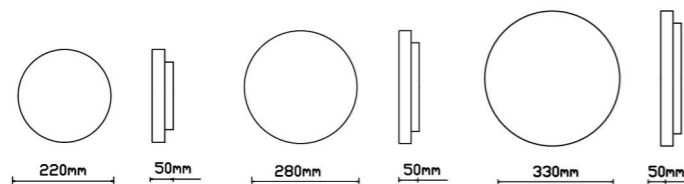

Item No	PPS-ML78L-15W-RE	PS-ML78L-18W-RE	PS-ML78L-24W-RE
Power	15W	18W	24W
Lumen	1350lm	1530lm	2000lm
LED	75pcs SMD2835	90pcs SMD2835	120pcs SMD2835
Color temperature	2700K-6500K, customized based on customer's requirement		
Meas	220×50mm	280×50mm	330×50mm

## PS-ML79L SERIES

- Material: PC/PC
- 220-240V AC
- Ra 80
- 90lm/w
- IP20
- Remote control

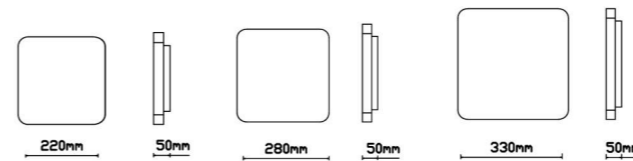

Item No	PPS-ML79L-15W-RE	PS-ML79L-18W-RE	PS-ML79L-24W-RE
Power	15W	18W	24W
Lumen	1350lm	1530lm	2000lm
LED	75pcs SMD2835	90pcs SMD2835	120pcs SMD2835
Color temperature	2700K-6500K, customized based on customer's requirement		
Meas	220×220×50mm	280×280×50mm	330×330×50mm

## PS-ML82L-24W-RE

- Material: PC/PC
- 220-240V AC
- Ra 80
- 90lm/w
- IP20
- Remote control

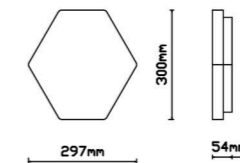
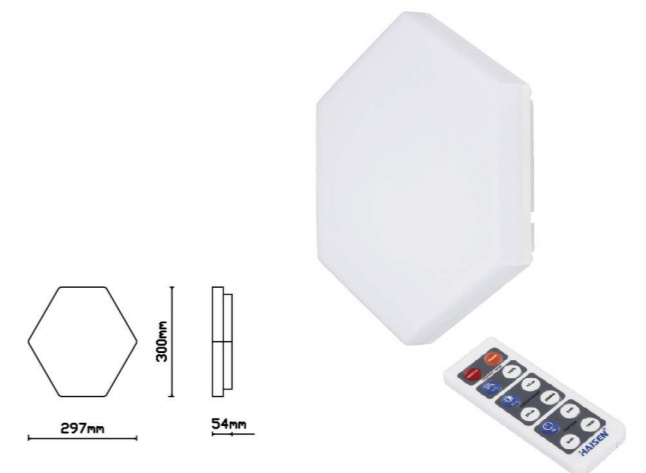

Item No	PPS-ML82L-24W-RE
Power	24W
Lumen	2000lm
LED	193pcs SMD2835
Color temperature	2700K-6500K, customized based on customer's requirement
Meas	300×54mm

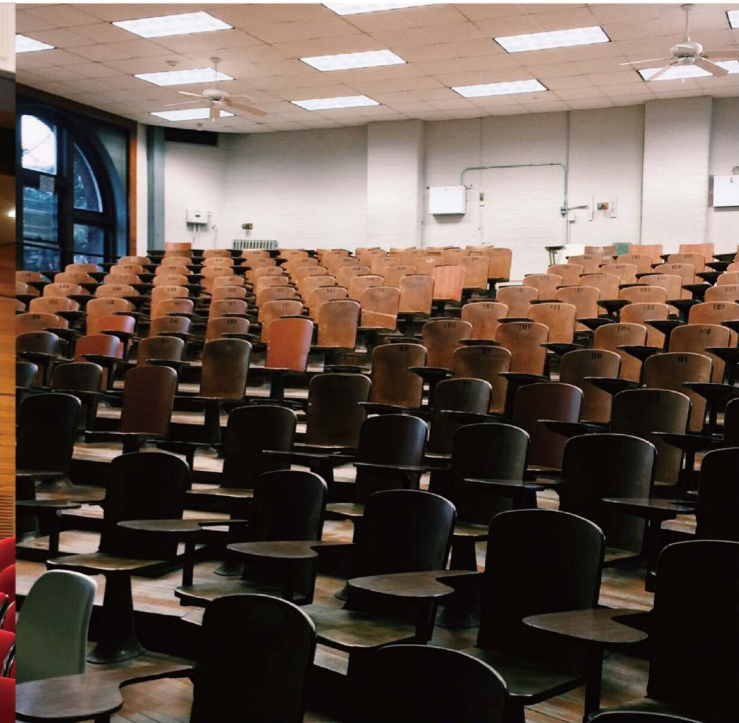

PS-BL98L-24W

PS-BL97L SERIES

- Back light: ice blue/ pink/ sky blue/ gold
- Material: PC/ PC
- 100-240V AC
- Ra 80
- 100lm/w
- IP20

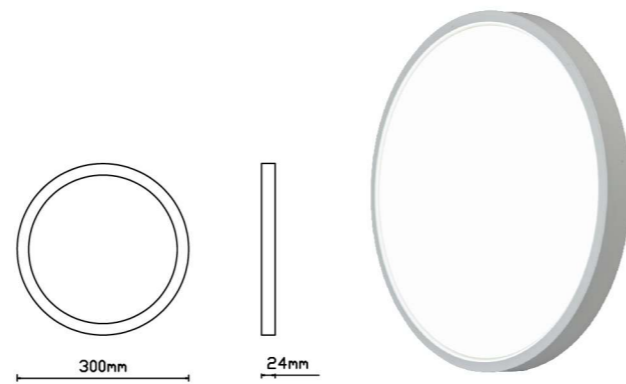

Item No	PS-BL98L-24W			
Power	20W+4W			
Lumen	2000lm+400lm			
LED	100pcs+20pcs SMD2835			
Color temperature	2700K-6500K, based on customer's requirement			
Frame color and backlight color	gold	ice blue	sky blue	pink
Meas	dia300×24mm			

- Back light: 3000K/ 4000K/ 6500K the same as light's color temperature
- Material: PMMA+PP+ABS
- 175-240V AC
- Ra 80
- 90lm/w
- IP20

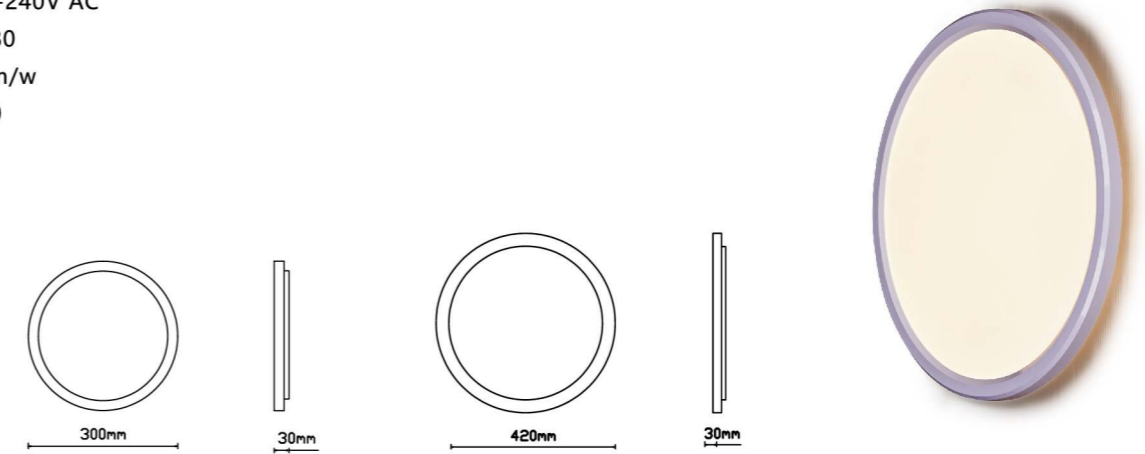

Item No	PS-BL97L-18W	PS-BL97L-24W
Power	18W	24W
Lumen	1620lm	2160lm
LED	90pcs SMD2835	120pcs SMD2835
Color temperature	3000K/ 4000K/ 6500K	
Meas	dia300×30mm	dia420×30mm





Wireless communication microwave sensor:

- Stand-by dim time: 24h/ 30s / 1min / 5min/ 10min / 30min /1h / 2h
- Stand-by brightness: 0%/ 5%/ 10%/ 20%/ 30%/ 40%/ 50% / 60%.
- Detect distance (radii.): 2-10m, adjustable
- Hold time: 10sec- 5min, adjustable .
- Daylight sensor: 2-2000LUX, adjustable
- Detection angle: 360°x180°
- Max: 16 groups .
- Wireless distance: 20m in open area
- Frequency: 433.92 MHz



Item NO	PS-ML105L-D-RF	PS-ML106L-D-RF	PS-ML16L-D-RF	PS-ML3001-1L-D-RF	PS-ML35L-D-RF-25W	PS-ML36L-D-RF-25W
Power	16W	16W	16W	16W	25W	25W
LED	96pcs SMD2835	96pcs SMD2835	96pcs SMD2835	96pcs SMD2835	160pcs SMD2835	160pcs SMD2835
Luminous flux	1200lm	1200lm	1200lm	1200lm	2000lm	2000lm
CRI	≥80	≥80	≥80	≥80	≥80	≥80
Material (diffuser/base)	PC	PC	PC	PC	PC/Aluminium dia-casting	PC/Aluminium dia-casting
IP rating	IP54	IP65	IP66	IP54	IP54	IP20
Meas	dia340*115mm	dia297*101mm	dia300*120mm	dia332*86mm	dia300*85mm	dia300*90mm

- It is an ideal choice for automatic lighting application in the long corrior, stairs or public area
- With the RF digital communication function the lights don't need to be wired in series and achieve light on/ stand-by dim/ off in groups by motion detection
- RF transmission upto 20m in open area
- 4 dips for group setting, up to 16 groups possible
- RF on or off adjustable, have Forward and Half brightness button

Application example:

In this stairs application, each floor is 2.5m, the walker up to each floor uses 5 minutes, all the sensors are set as following:  
 same group address coding | 15min motion hold time | 50lux daylight sensor | 5min detection range | 10% stand-by brightness | 5min stand-by time!

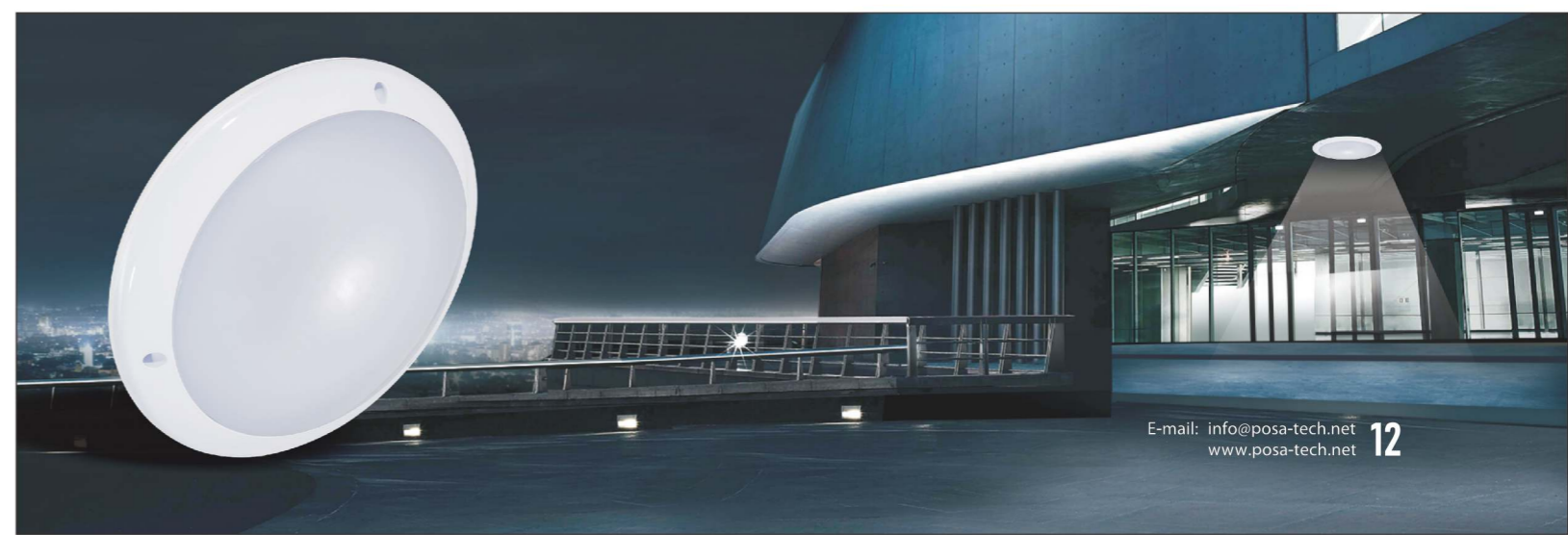



**CCT ADJUSTABLE CEILING LIGHT  
MICROWAVE MOTION SENSOR LIGHT  
LED CEILING LIGHT**



**78L SERIES**

**CCT adjustable ceiling light**

- CCT: 3000K/4000K/6500K adjustable

**Microwave motion sensor light**

- IP20
- 220-240V AC
- HF Sensor:
  - Time delay: 1min
  - Detection range: 10m
  - Light control: 10Lux
  - Detection angle: 360°

← 3000K, 4000K, 6500K CCT adjustment →

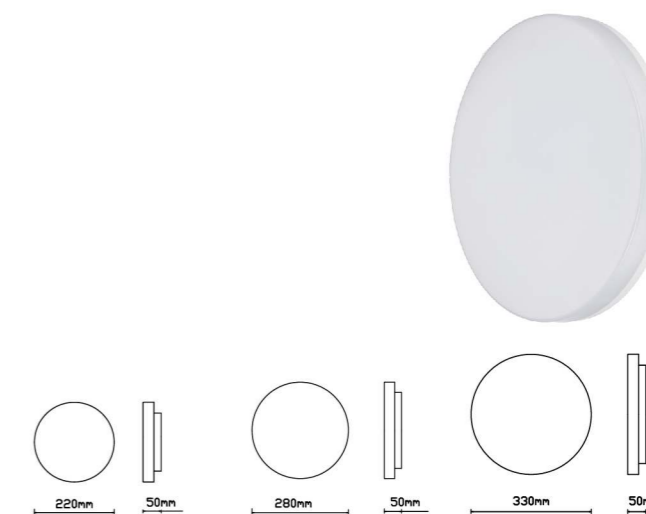

Item NO	Power	LED	Luminous Flux	CRI	CCT adjustable	Microwave sensor	Material	Meas
PS-CL78L-15W-DCT	15W	75pcs SMD2835	1350lm	≥80	×	-	PC/PC	dia220×50mm
PS-ML78L-15W					-	×		
PS-CL78L-15W					-	-		
PS-CL78L-18W-DCT	18W	90pcs SMD2835	1530lm	≥80	×	-	PC/PC	dia280×50mm
PS-ML78L-18W					-	×		
PS-CL78L-18W					-	-		
PS-CL78L-24W-DCT	24W	120pcs SMD2835	2000lm	≥80	×	-	PC/PC	dia330×50mm
PS-ML78L-24W					-	×		
PS-CL78L-24W					-	-		

## 79L SERIES

### CCT adjustable ceiling light

- CCT: 3000K/4000K/6500K adjustable

### Microwave motion sensor light

- IP20
- 220-240V AC
- HF Sensor:
  - Time delay: 1min
  - Detection range: 10m
  - Light control: 10Lux
  - Detection angle: 360°

← 3000K, 4000K, 6500K CCT adjustment →

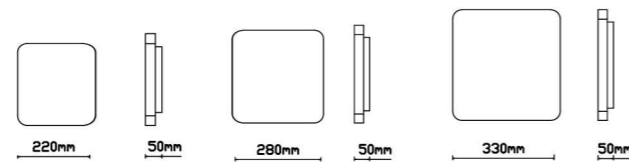

Item NO	Power	LED	Luminous Flux	CRI	CCT adjustable	Microwave sensor	Material	Meas
PS-CL79L-15W-DCT	15W	75pcs SMD2835	1350lm	≥80	×	-	PC/PC	dia220×220×50mm
PS-ML79L-15W					-	×		
PS-CL79L-15W					-	-		
PS-CL79L-18W-DCT	18W	90pcs SMD2835	1530lm	≥80	×	-	PC/PC	dia280×280×50mm
PS-ML79L-18W					-	×		
PS-CL79L-18W					-	-		
PS-CL79L-24W-DCT	24W	120pcs SMD2835	2000lm	≥80	×	-	PC/PC	dia330×330×50mm
PS-ML79L-24W					-	×		
PS-CL79L-24W					-	-		

## 80L SERIES

- IP54
- 220-240V AC
- HF Sensor:
  - Time delay: 5sec,3min,8min,12min, adjustable
  - Detection range: 2m, 4m, 6m, 10m(radii.), adjustable
  - Light control: 10lux, 20lux, 50lux, 2000lux, adjustable
  - Detection angle: 360°

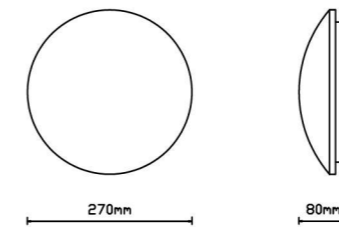

Item NO	Power	LED	Luminous Flux	CRI	CCT adjustable	Microwave sensor	Material	Meas
PS-ML80L	16W	88pcs SMD2835	1200lm	≥80	-	×	PC/PC	dia270×80mm
PS-CL80L					-	-		

## 81L SERIES

- IP20
- 220-240V AC
- HF Sensor:
  - Time delay: 1min
  - Detection range: 10m
  - Light control: 10Lux
  - Detection angle: 360°

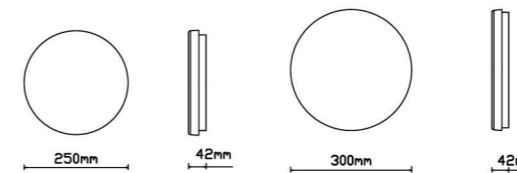

Item NO	Power	LED	Luminous Flux	CRI	CCT adjustable	Microwave sensor	Material	Meas
PS-ML81L-12W	12W	224pcs SMD2835	1000lm	≥80	-	×	PC/PC	dia250×42mm
PS-CL81L-12W					-	-		
PS-ML81L-15W	15W	224pcs SMD2835	1240lm	≥80	-	×	PC/PC	dia250×42mm
PS-CL81L-15W					-	-		
PS-ML81L-24W	24W	300pcs SMD2835	2350lm	≥80	-	×	PC/PC	dia300×42mm
PS-CL81L-24W					-	-		

## 82L SERIES

### CCT adjustable ceiling light

- CCT: 3000K/4000K/6500K adjustable

### Microwave motion sensor light

- IP20
- 220-240V AC
- HF Sensor:
  - Time delay: 1min
  - Detection range: 10m
  - Light control: 10Lux
  - Detection angle: 360°

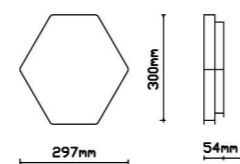

Item NO	Power	LED	Luminous Flux	CRI	CCT adjustable	Microwave sensor	Material	Meas
PS-ML82L-24W	24W	193pcs SMD2835	2000lm	≥80	-	×	PC/PC	300×54mm
PS-CL82L-24W					-	-		

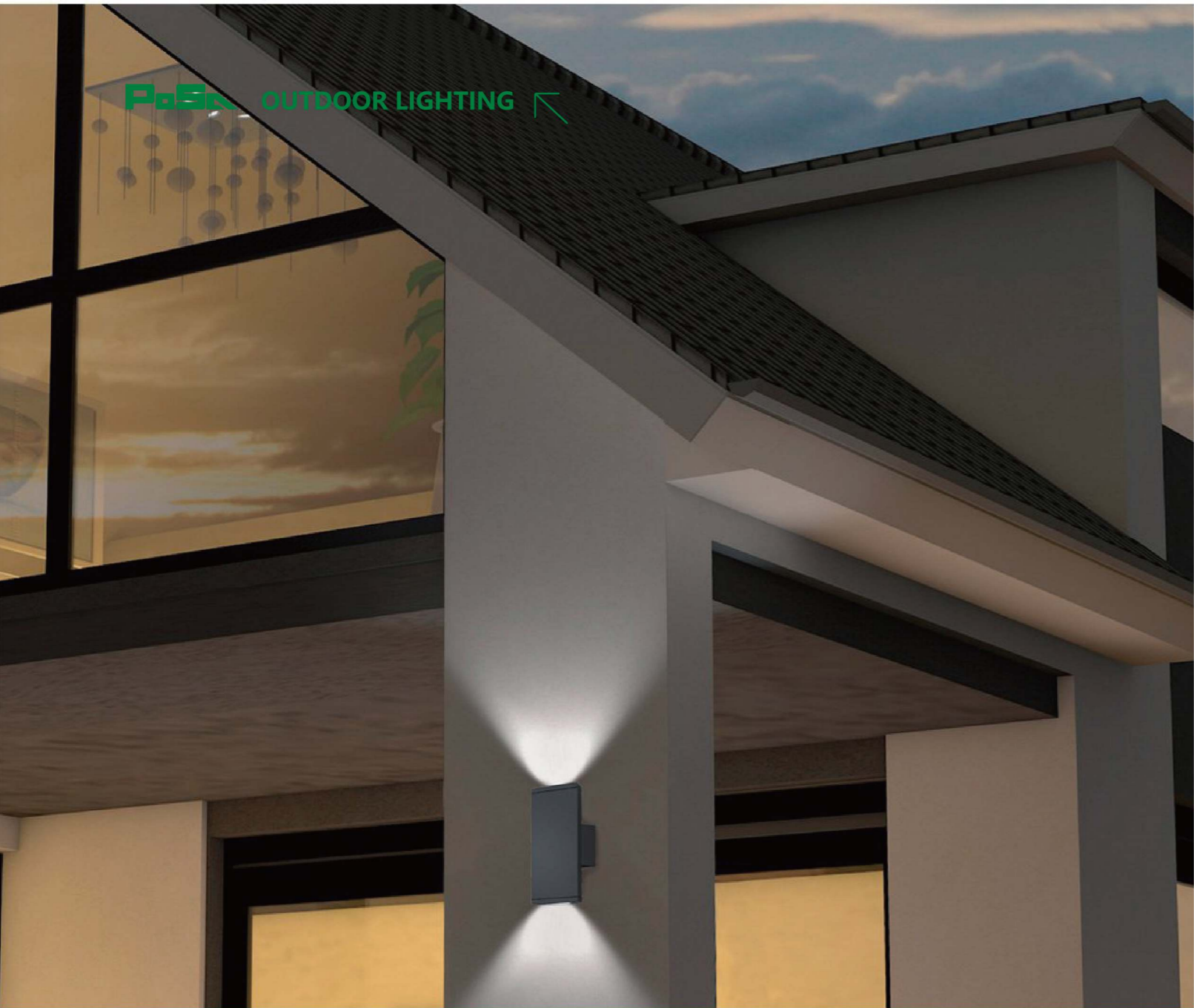

# OUTDOOR LIGHTING

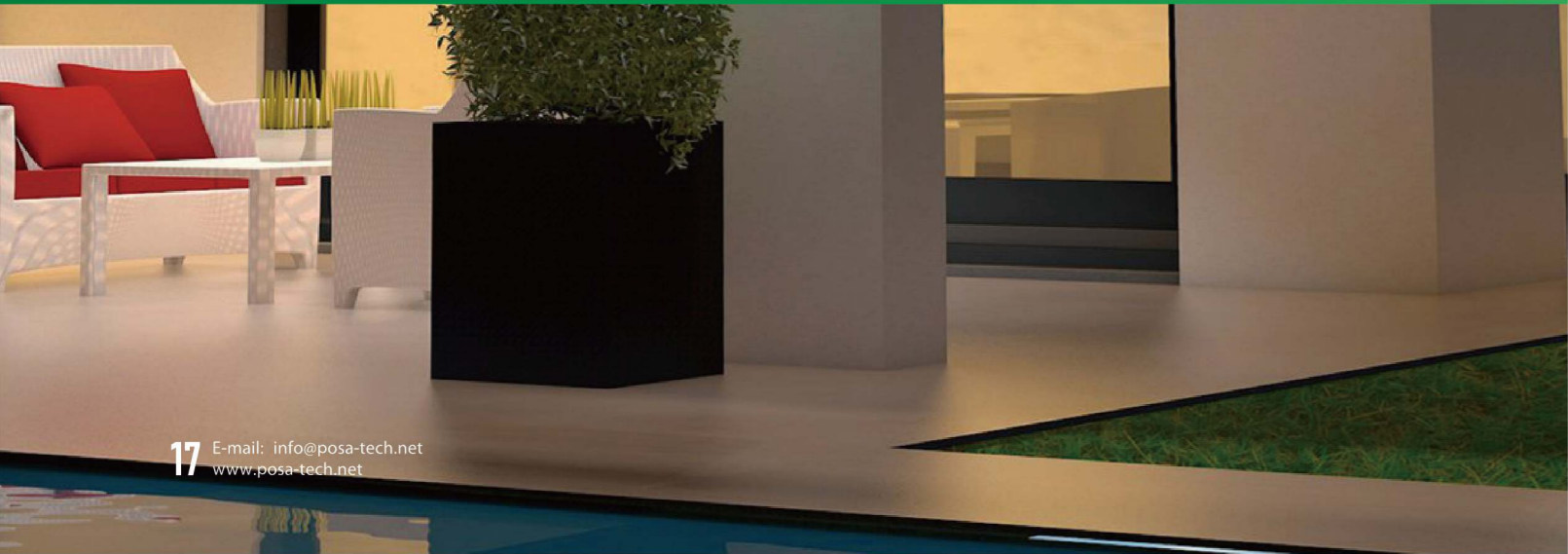

**PS-WL58L Technical data:**

- Power: 4W
- LED Chip: 4xCOB
- Luminous Flux: 240lm
- CRI: ≥80
- Material: Die-casting aluminum
- IP Rating: IP65

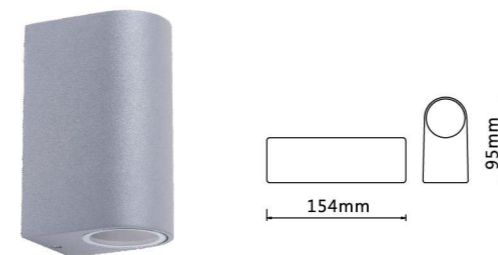

**PS-WL02-2 Technical data:**

- Lampholder: 2xGU10
- Max. loading power: 35W
- Material: Die-casting aluminum body, glass diffuser
- IP Rating: IP54

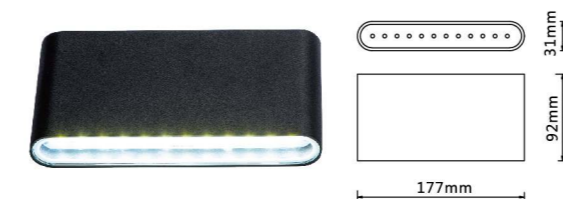

**PS-WL64L-6W Technical data:**

- Power: 2x3W
- LED Chip: 2xCOB
- Luminous Flux: 360lm
- CRI: ≥80
- Material: Die-casting aluminum body, glass diffuser
- IP Rating: IP44

**PS-WL64L-10W Technical data:**

- Power: 2x5W
- LED Chip: 2xCOB
- Luminous Flux: 600lm
- CRI: ≥80
- Material: Die-casting aluminum body, glass diffuser
- IP Rating: IP44



**PS-WL69L Technical data:**

- Power: 7W
- LED Chip: 1xCOB
- Luminous Flux: 550lm
- CRI: ≥80
- Material: Die-casting aluminum body, PC diffuser
- IP Rating: IP65



**PS-WL68L Technical data:**

- Power: 6W
- LED Chip: 2xCOB
- Luminous Flux: 400lm
- CRI: ≥80
- Material: Die-casting aluminum body, PC diffuser
- IP Rating: IP54



**PS-WL046 Technical data:**

- Lampholder: E27
- Max. loading power: 60W
- Material: PC
- IP Rating: IP44



# OUTDOOR LIGHTING

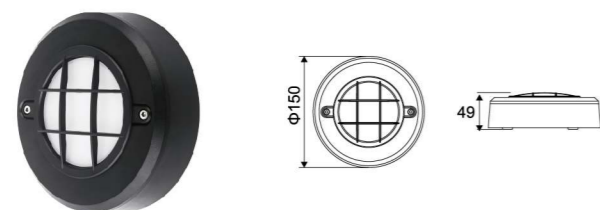

**PS-WL79L-C Technical data:**

- Power: 3.5W
- LED Chip: 38pcs 2835SMD
- Luminous Flux: 160lm
- CRI: 80
- Material: ABS+PC material, PC diffuser
- IP Rating: IP65



**PS-WL79L-D Technical data:**

- Power: 3.5W
- LED Chip: 38pcs 2835SMD
- Luminous Flux: 40lm
- CRI: 80
- Material: ABS+PC material, PC diffuser
- IP Rating: IP65

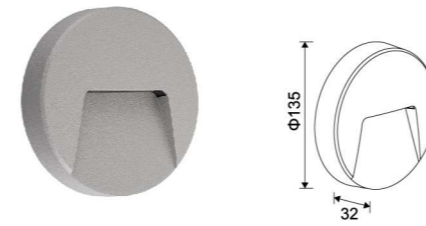

**PS-WL80L Technical data:**

- Power: 3W
- LED Chip: 11pcs 2835SMD
- Luminous Flux: 100lm
- CRI: 80
- Material: ABS+PC material, PC diffuser
- IP Rating: IP65

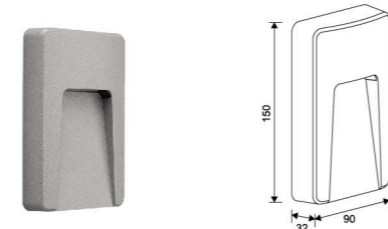

**PS-WL82L Technical data:**

- Power: 3W
- LED Chip: 10pcs 2835SMD
- Luminous Flux: 100lm
- CRI: 80
- Material: ABS+PC material, PC diffuser
- IP Rating: IP65



**PS-WL84L Technical data:**

- Lamp holder: E27, Max.40W
- Material: ABS+PC material, frost PC diffuser
- IP Rating: IP44

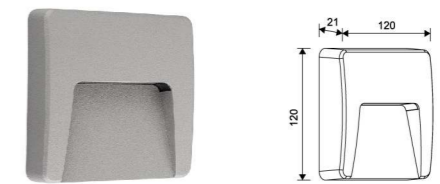

**PS-WL81L Technical data:**

- Power: 3W
- LED Chip: 11pcs 2835SMD
- Luminous Flux: 100lm
- CRI: 80
- Material: ABS+PC material, PC diffuser
- IP Rating: IP65

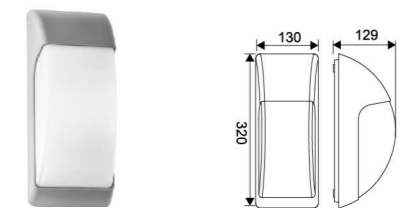

**PS-WL83L Technical data:**

- Lamp holder: E27, Max.18W
- Material: ABS+PC material, PC diffuser
- IP Rating: IP65

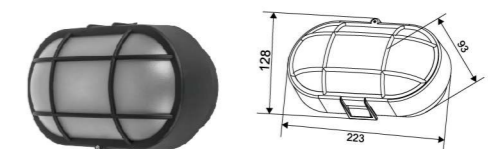

**PS-WL85L Technical data:**

- Lamp holder: E27, Max.40W
- Material: ABS+PC material, frost PC diffuser
- IP Rating: IP44



PS-WL29L-2W / PS-WL29L-4W



PS-WL40L-3W



PS-WL36L-3.5W



PS-WL41L-1.5W

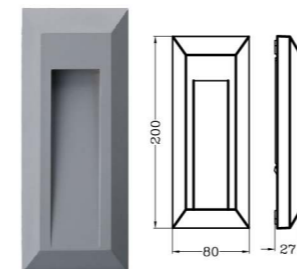

PS-WL37L-1W

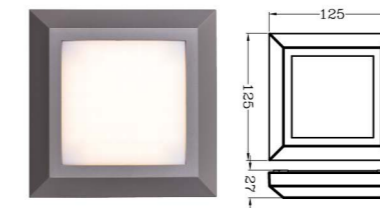

PS-WL38L-4.5W

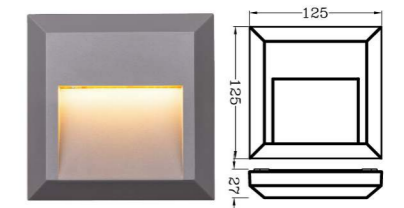

PS-WL39L-1.6W

Item No	Power	LED	Luminous Flux	CRI	Material (diffuser/base)	IP Rating
PS-WL29L-2W	2W	24×SMD3528	140lm	≥80	PC/ABS	IP65
PS-WL29L-4W	4W	40×SMD3014	280lm	≥80	PC/ABS	IP65
PS-WL36L-3.5W	3.5W	35×SMD3014	180lm	≥80	PC/ABS	IP65
PS-WL37L-1W	1W	9×SMD3014	50lm	≥80	PC/ABS	IP65
PS-WL38L-4.5W	4.5W	45×SMD3014	290lm	≥80	PC/ABS	IP65
PS-WL39L-1.6W	1.6W	16×SMD3014	120lm	≥80	PC/ABS	IP65
PS-WL40L-3W	3W	40×SMD3014	250lm	≥80	PC/ABS	IP65
PS-WL41L-1.5W	1.5W	20×SMD3014	130lm	≥80	PC/ABS	IP65

# OUTDOOR LIGHTING

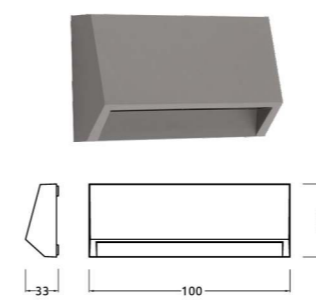
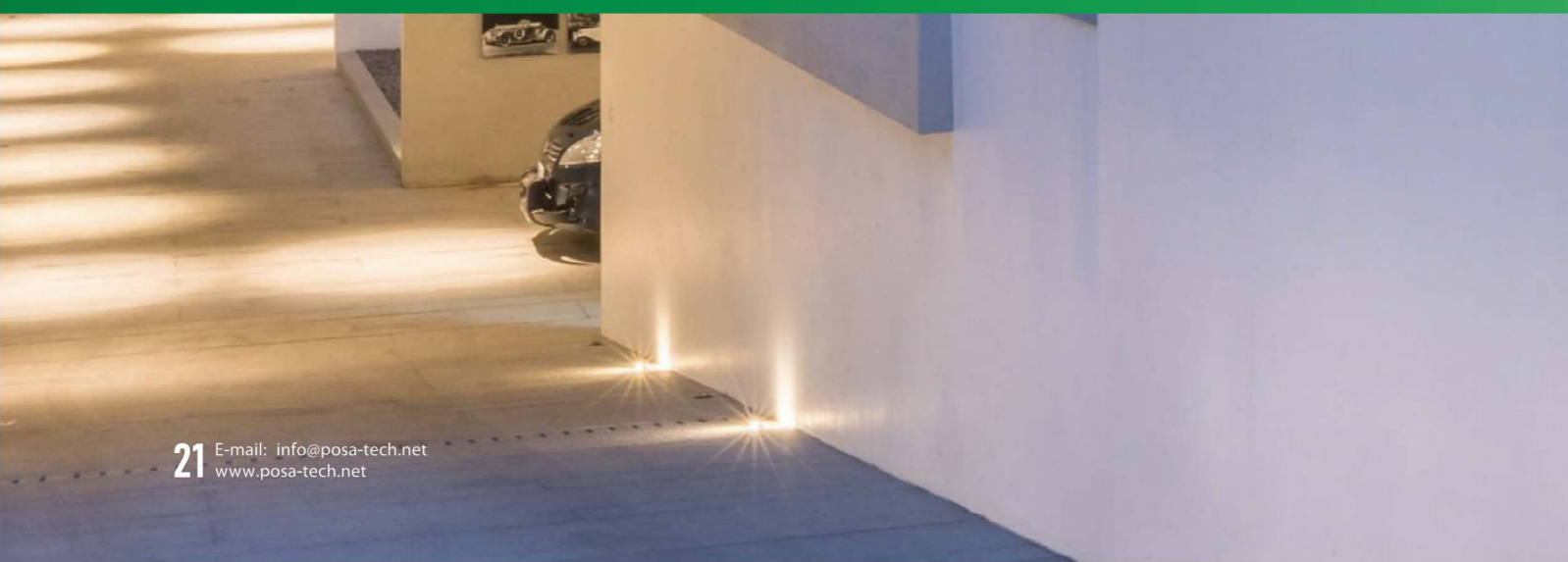

PS-WL42L-2W

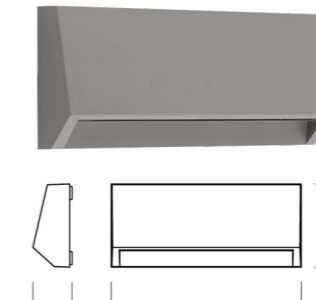

PS-WL42L-3.8W

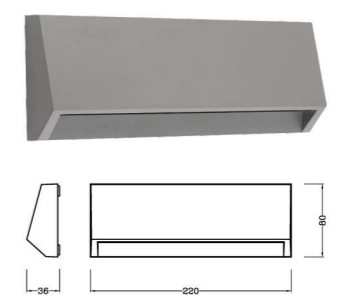

PS-WL42L-5W

Item No	Power	LED	Luminous Flux	CRI	Material (diffuser/base)	IP Rating
PS-WL42L-2W	2W	12×SMD2835	114lm	≥80	PC/ABS	IP65
PS-WL42L-3.8W	3.8W	20×SMD2835	217lm	≥80	PC/ABS	IP65
PS-WL42L-5W	5W	28×SMD2835	370lm	≥80	PC/ABS	IP65

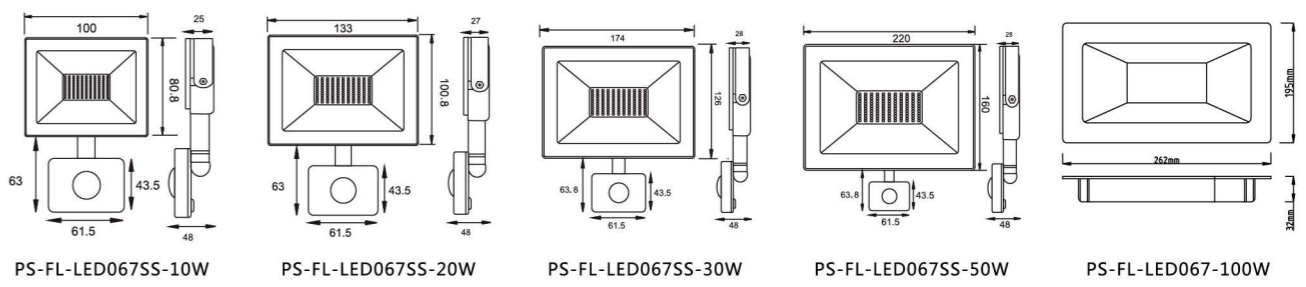

- Material: aluminium Die-casting body, tempered glasses, steel bracket
- Input Voltage: AC180-240V 50/60HZ
- Power Factor: 0.92
- Color of body: customized based on customer's requirement
- Color Instruction: >80

**PIR sensor version:**

- Detect distance (dia.): 2-6m, adjustable
- Hold time: 10sec-10min, adjustable
- Daylight sensor: 2-2000lux, adjustable

Item No	Power	LED	Luminous Flux	Meas	IP Rating	PIR sensor
PS-FL-LED067SS-10W	10W	28×SMD2835	1000lm	10*14.38*4.8CM	IP44	×
PS-FL-LED067-10W				10*8*2.4CM	IP65	-
PS-FL-LED067SS-20W	20W	28×SMD2835	2000lm	13.3*16.38*4.8CM	IP44	×
PS-FL-LED067-20W				14*11*2.4CM	IP65	-
PS-FL-LED067SS-30W	30W	42×SMD2835	3000lm	17.4*18.98*4.8CM	IP44	×
PS-FL-LED067-30W				17*13.5*2.7CM	IP65	-
PS-FL-LED067SS-50W	50W	70×SMD2835	5000lm	22*22.38*4.8CM	IP44	×
PS-FL-LED067-50W				22.5*17*3CM	IP65	-
PS-FL-LED067SS-100W	100W	140×SMD2835	9500lm	26.2*25.88*4.8CM	IP44	×
PS-FL-LED067-100W				26*20*3.5CM	IP65	-
PS-FL-LED067-150W	150W	210×SMD2835	14250lm	33*24.5*4CM	IP65	-
PS-FL-LED067-200W	200W	280×SMD2835	19000lm	33*24.5*4CM	IP65	-
PS-FL-LED067-300W	300W	420×SMD2835	28500lm	38*28.5*4.7CM	IP65	-
PS-FL-LED067-400W	400W	560×SMD2835	38000lm	42.5*31.5*4.7CM	IP65	-



# LED FLOODLIGHT



PS-FL-LED082-10W

PS-FL-LED082-30W

PS-FL-LED082SS-10W



PS-FL-LED082SS-30W



PS-FL-LED082SS-50W



PS-FL-LED082SS-100W

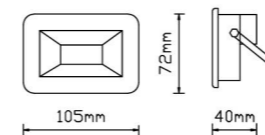

PS-FL-LED082-10W

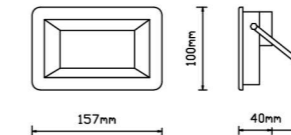

PS-FL-LED082-30W

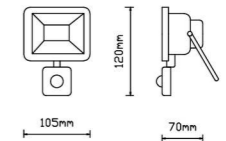

PS-FL-LED082SS-10W

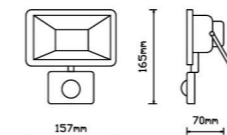

PS-FL-LED082SS-30W

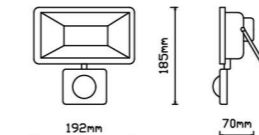

PS-FL-LED082SS-50W

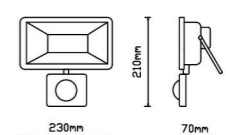

PS-FL-LED082SS-100W

- Material: aluminium Die-casting body, tempered glasses, steel bracket, with junction box
- Input Voltage: AC180-240V, 110-240V
- Power Factor: 0.90
- Color of body: customized based on customer's requirement
- Color Instruction: >80

**PIR sensor version:**

- Detect distance (dia.): 2-6m, adjustable
- Hold time: 10sec-10min, adjustable
- Daylight sensor: 2-2000lux adjustable

Item No	Power	LED	Luminous Flux	Meas	IP Rating	PIR sensor
PS-FL-LED082SS-10W	10W	28×SMD2835	900lm	10.5*7*12.5CM	IP44	×
PS-FL-LED082-10W				10.5*4*7.2CM	IP65	-
PS-FL-LED082SS-20W	20W	28×SMD2835	1800lm	12*7*13.5CM	IP44	×
PS-FL-LED082-20W				12*4*8CM	IP65	-
PS-FL-LED082SS-30W	30W	42×SMD2835	2700lm	15.7*7*16.5CM	IP44	×
PS-FL-LED082-30W				15.7*4*10CM	IP65	-
PS-FL-LED082SS-50W	50W	70×SMD2835	4500lm	19.2*7*18.5CM	IP44	×
PS-FL-LED082-50W				19.2*4*13CM	IP65	-
PS-FL-LED082SS-100W	100W	140×SMD2835	9000lm	23*7*21CM	IP44	×
PS-FL-LED082-100W				23*4*15CM	IP65	-
PS-FL-LED082SS-150W	150W	210×SMD2835	13500lm	28*7.5*25CM	IP44	×
PS-FL-LED082-150W				28*4.5*19CM	IP65	-
PS-FL-LED082SS-200W	200W	280×SMD2835	18000lm	32*7.5*28CM	IP44	×
PS-FL-LED082-200W				32*4.5*21.7CM	IP65	-





# WORK LIGHT



### Work Light

- Aluminum Die-casting body, PC Reflector, Tempered glass
- Input Voltage: AC85-265V 50/60HZ
- With 1.5M 3X0.75m<sup>2</sup> H05RN-F waterproof plug
- Power Factor: 0.92
- IP Rating: IP65
- Color Instruction: >80
- Body Color: Black/White/Red/Yellow



Item No	LED	Power	Luminous flux	Meas
PS-FL-LED072-10W	28×SMD2835	10W	800lm	27*22*5.5cm
PS-FL-LED072-20W	54×SMD2835	20W	1600lm	27*22*5.5cm
PS-FL-LED072-30W	78×SMD2835	30W	2400lm	29*26.5*5.5cm
PS-FL-LED072-50W	156×SMD2835	50W	4000lm	31.5*35*5.5cm
PS-FL-LED072-100W	312×SMD2835	100W	8000lm	35.5*45.5*5.5cm

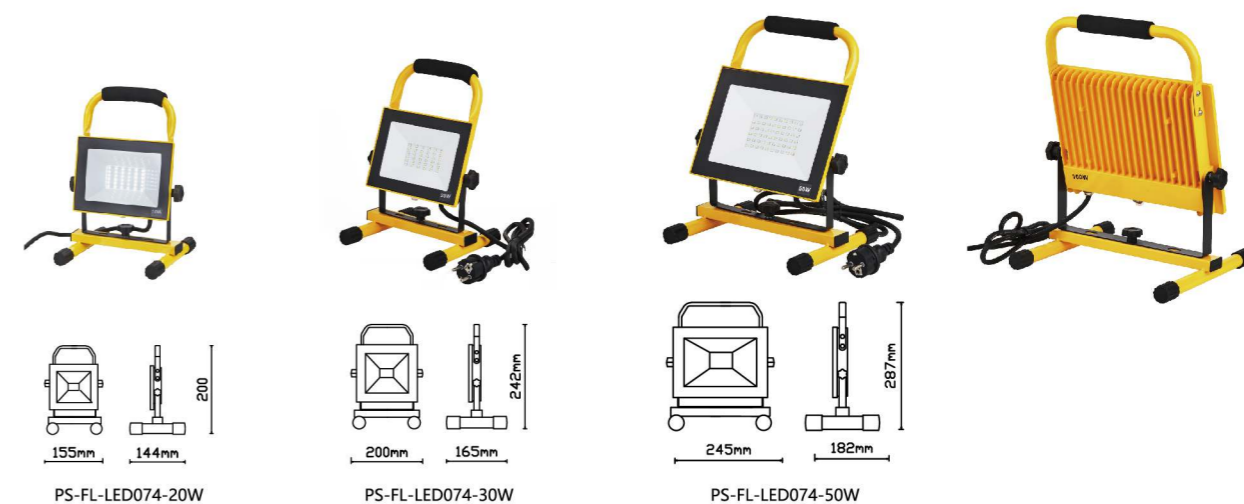

Item No	LED	Power	Luminous flux	Meas
PS-FL-LED074-10W	28×SMD2835	10W	800lm	14.4*16.2*20cm
PS-FL-LED074-20W	54×SMD2835	20W	1600lm	14*16.2*24cm
PS-FL-LED074-30W	78×SMD2835	30W	2400lm	21.5*18.3*24.2cm
PS-FL-LED074-50W	156×SMD2835	50W	4000lm	24.6*19.2*28.7cm
PS-FL-LED074-100W	312×SMD2835	100W	8000lm	27.2*22.3*33.6cm



**LED RECHARGEABLE  
WORK LIGHT**



**Rechargeable Work Light**

- Aluminum Die-casting body, PC Reflector, Tempered glass
- Input Voltage: AC85-265V 50/60HZ
- With Charger and Car Charger
- IP Rating: IP65
- Color Instruction: >80
- Body Color: Black/ White/ Red/ Yellow



Item No	LED	Power	Luminous flux	Meas	Rechargeable	Running time
PS-FL-LED078-10W	28×SMD2835	10W	500lm	27*22*5.5cm	×	3 hours
PS-FL-LED078-20W	54×SMD2835	20W	1000lm	29*26.5*5.5cm	×	2 hours
PS-FL-LED078-30W	78×SMD2835	30W	1500lm	31.5*35*5.5cm	×	2 hours
PS-FL-LED078-50W	156×SMD2835	50W	2500lm	35.5*45.5*5.5cm	×	2 hours



Item No	LED	Power	Luminous flux	Meas	Rechargeable	Running time
PS-FL-LED080-10W	28×SMD2835	10W	500lm	14.4*16.2*20cm	×	3 hours
PS-FL-LED080-20W	54×SMD2835	20W	1000lm	21.5*18.2*24.2cm	×	2 hours
PS-FL-LED080-30W	78×SMD2835	30W	1500lm	24.6*19.2*28.7cm	×	2 hours
PS-FL-LED080-50W	156×SMD2835	50W	2500lm	27.2*22.3*33.6cm	×	2 hours

**LED dusk-to-dawn bulb**

- Daylight - the bulb is off all of the time
- Evening- The light automatically comes on when the ambient lux drops around 15lux
- Morning As the morning comes and light level is
- above around 40lux, the bulb switches off completely.



PS-PLB52LUX-3, 5, 7W

Item No	Input voltage	Lampholder	Type	LED	Power	Luminous Flux	CRI	Material(diffuser/base)
PS-PLB52LUX-3W	85-265V/AC	E27/B22	A60	3XSMD5730	3W	195lm	80	PC/ Plastic coated aluminum
PS-PLB52LUX- 5W			A60	5XSMD5730	5W	330lm	80	
PS-PLB52LUX-7W			A60	7XSMD5730	7W	460lm	80	
PS-PLB52LUX-9W			A60	9XSMD5730	9W	590lm	80	
PS-PLB52LUX-12W			A60	12XSMD5730	12W	780lm	80	

**LED microwave sensor & dusk-to-dawn bulb, 2-in-1**

- Daylight-the bulb is off all of the time
- Evening-the light automatically comes on when the ambient lux below 20lux and has motion detection
- Detect distance: 4-5m, radii
- Hold time: 1min
- Press the switch twice to turn off the sensor function



PS-PLB03RS-8W

Item No	Input voltage	Lampholder	Type	LED	Power	Luminous Flux	CRI	Material(diffuser/base)
PS-PLB03RS-10W	220-240V/AC	E27/B22	A65	70XSMD2835	10W	800lm	80	PC/Plastic coated aluminum

**LED DUSK TO DAWN BULB  
LED MICROWAVE SENSOR  
DUSK-TO-DAWN BULB**

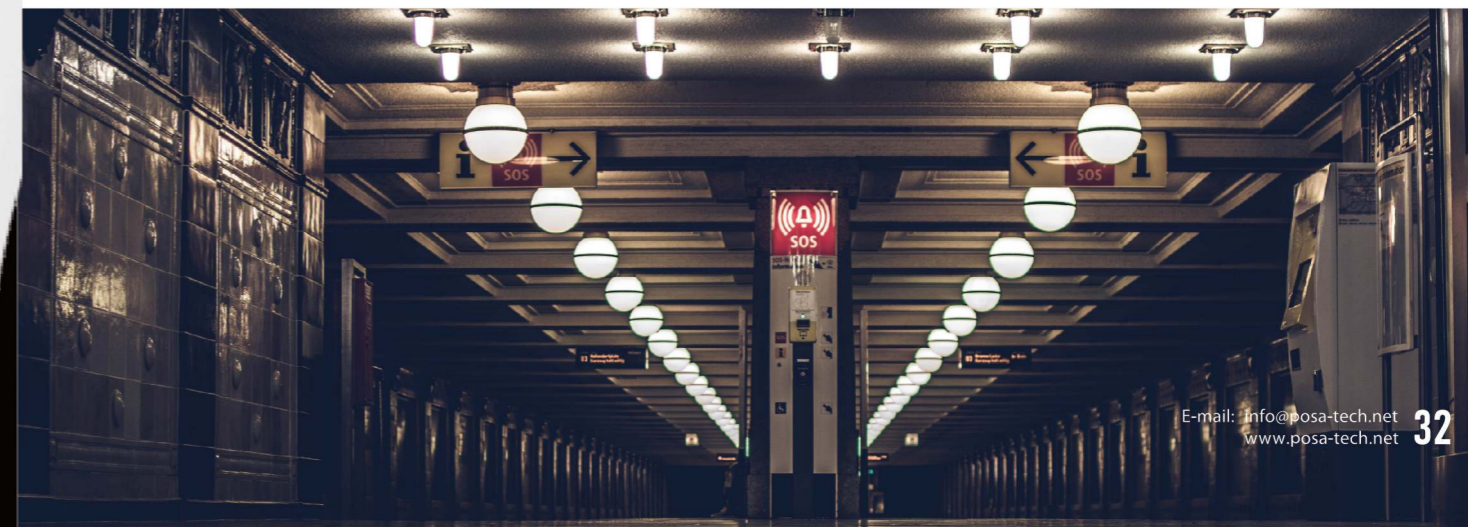

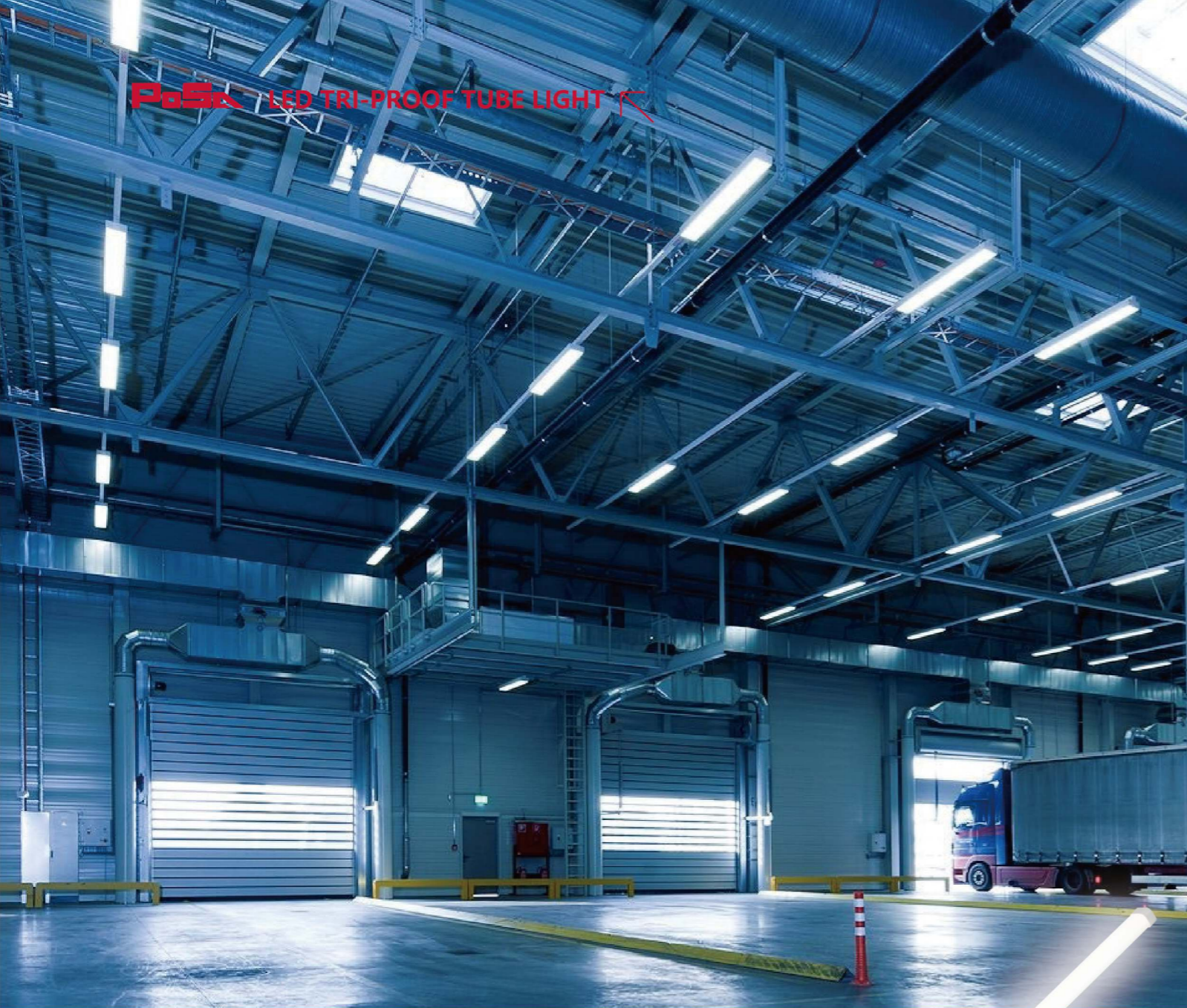

## LED TRI-PROOF TUBE LIGHT WITH MICROWAVE MOTION SENSOR OR WITHOUT

### LED tri-proof tube light with microwave motion sensor or without

- It is the LED tube design, but work as the LED tri-proof light
- Using the newest Nano material for the housing
- High lighting efficiency: 18W, 1620LM
- Good protection: IP65 including waterproof and dust-proof
- Easy wire connection

### HF Sensor:

- Time delay: 10sec
- Detection range: 10m
- Light control: 2000LUX
- Detection angle: 360°

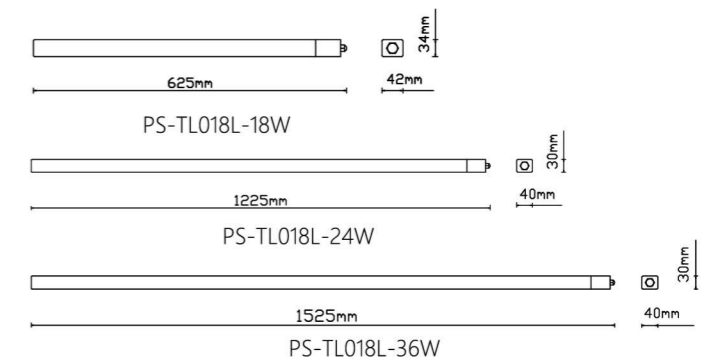

Item No	Input voltage	LED	Power	Luminous flux	Microwave sensor	CRI	Material	IP rating	Meas
PS-TL018SL-18W	180-265V/AC	90×SMD2835	18W	1620lm	×	80	Nano	IP65	625×42×34mm
PS-TL018L-18W		90×SMD2835	18W	1620lm	-				625×42×34mm
PS-TL018SL-24W		120×SMD2835	24W	2160lm	×				1225×40×30mm
PS-TL018L-24W		120×SMD2835	24W	2160lm	-				1225×40×30mm
PS-TL018SL-36W		180×SMD2835	36W	3240lm	×				1525×40×30mm
PS-TL018L-36W		180×SMD2835	36W	3240lm	-				1525×40×30mm

# MICROWAVE MOTION SENSOR ON/OFF VERSION



PS-RS02

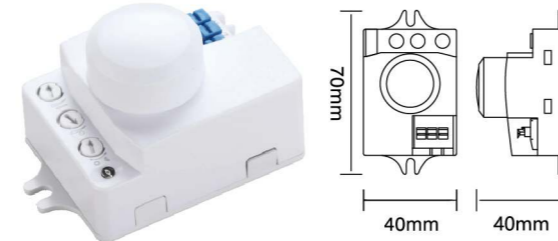

PS-RS02S



PS-RS06



PS-RS08

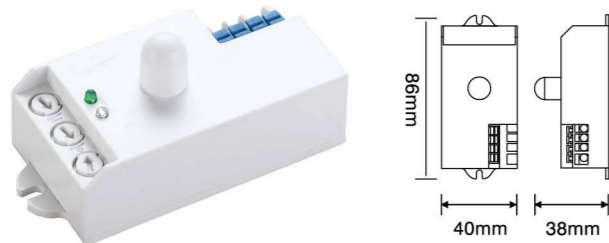

PS-RS09

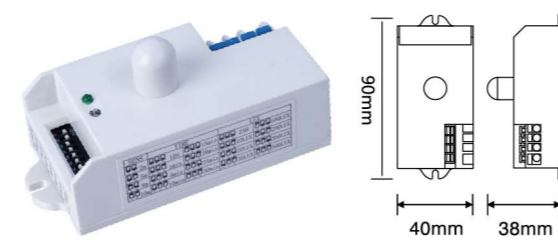

PS-RS12



PS-RS13

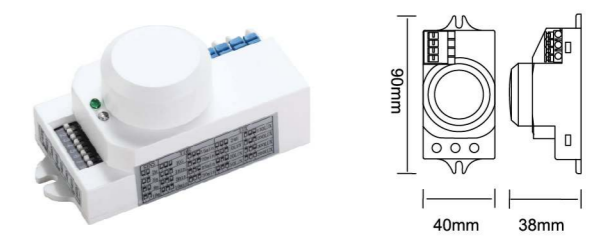

PS-RS18

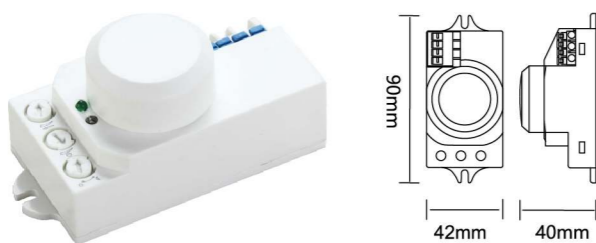

PS-RS19



PS-RS24

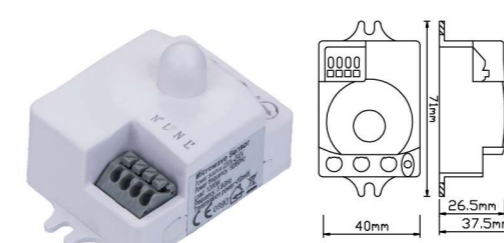

PS-RS31

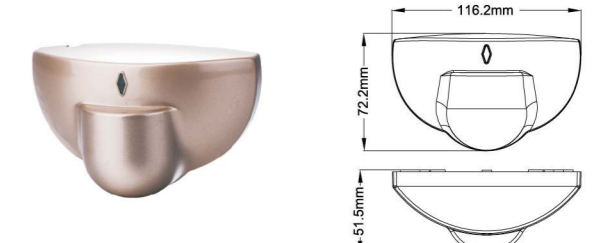

PS-RS39

Item No	Input voltage	Hold time
PS-RS02	220V-240V/AC, 110-130V/AC	8sec-12min
PS-RS02-24V	24V AC/DC	8sec-12min
PS-RS02S	220V-240V/AC, 110-130V/AC	10sec-12min
PS-RS06	90-250V/AC	6s / 1min / 3min / 5min / 10min / 15min
PS-RS08	220V-240V/AC, 110-130V/AC	10s / 1min / 5min / 10min / 15min / 20min / 25min / 30min
PS-RS09	220V-240V/AC, 110-130V/AC, 12-30V/DC	12sec-30min
PS-RS12	220V-240V/AC, 110-130V/AC, 12-30V/DC	10s / 1min / 5min / 10min / 15min / 20min / 25min / 30min
PS-RS13	220V-240V/AC, 110-130V/AC	10s / 1min / 5min / 10min / 15min / 20min / 25min / 30min
PS-RS18	220V-240V/AC, 110-130V/AC, 12-30V/DC	10s / 1min / 5min / 10min / 15min / 20min / 25min / 30min
PS-RS19	220V-240V/AC, 110-130V/AC	8sec-12min
PS-RS24	220V-240V/AC, 110-130V/AC	8sec/ 4min/ 8min/ 12min
PS-RS31	220V-240V/AC, 110-130V/AC	10sec-12min
PS-RS39	10V-24V/AC, 12-35V/DC	

Detect distance (radii.)	Daylight sensor	Mounting height	Adjustment type		IP rating
			Knob	Dip	
2-10m	2-2000lux	3.5m	×		IP20
2-10m	10-500lux	3.5m	×	-	IP20
2-10m	2-2000lux	3.5m	×		IP20
2m / 5m / 8m / 10m	10lux / 100lux / 300lux / 2000lux	3.5m		×	IP65
2m / 5m / 8m / 10m	10lux / 20lux / 50lux / 100lux / 200lux / 300lux / 500lux / 2000lux	3.5m		×	IP20
2-10m	10-2000lux	3.5m	×		IP20
2m / 5m / 8m / 10m	10lux / 20lux / 50lux / 100lux / 200lux / 300lux / 500lux / 2000lux	3.5m		×	IP20
2m / 5m / 8m / 10m	10lux / 20lux / 50lux / 100lux / 200lux / 300lux / 500lux / 2000lux	3.5m		×	IP20
2m / 5m / 8m / 10m	10lux / 20lux / 50lux / 100lux / 200lux / 300lux / 500lux / 2000lux	3.5m		×	IP20
2-10m	2-2000lux	3.5m	×		IP20
2m / 4m / 6m / 8m	10lux / 30lux / 50lux / 2000lux	3.5m		×	IP20
2-10m	2-2000lux	3.5m	×		IP20
1-7m		3.5m	×		IP20



**MICROWAVE MOTION SENSOR ON/OFF VERSION**

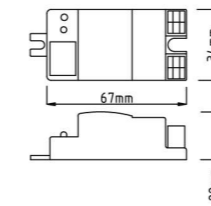

PS-RS46

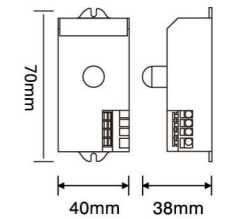

PS-RS47

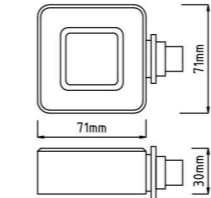

PS-RS48

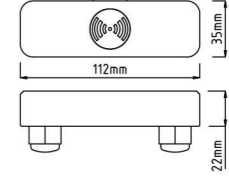

PS-RS49

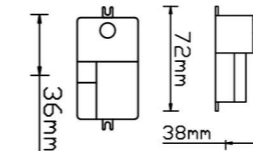

PS-RS65

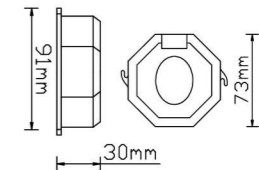

PS-RS66

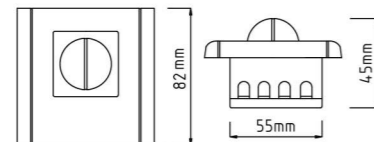

PS-RS43

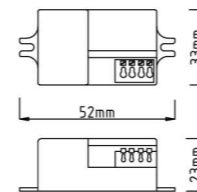

PS-RS45

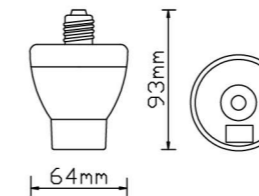

PS-RS67

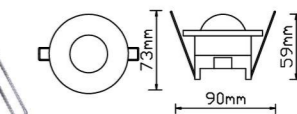

PS-RS41

Item No	Input voltage	Hold time
PS-RS43	110-130V/AC, 220-240V/AC	3sec/ 45sec/ 4min (Dip)
PS-RS45	220-240V/AC	5s/1min/3min/10min
PS-RS46	220V-240V/AC, 110-130V/AC	8s/ 3min/ 8min/ 12min
PS-RS47	220V-240V/AC, 110-130V/AC	8s/ 3min/ 8min/ 12min
PS-RS48	110-240V/AC	10sec-12min
PS-RS49	110-130V/AC, 220-240V/AC	5sec / 90sec / 3min / 20min
PS-RS65	110-130V/AC, 220-240V/AC	5s/ 3min
PS-RS66	100-240V/AC	15sec±3sec/ 1min±10sec/ 3min±30sec/ 10min±1min
PS-RS67	90-230VAC	5sec/ 1min/ 3min/ 8min
PS-RS41	110-130V/AC, 220-240V/AC	10sec-12min

Detect distance (radial.)	Daylight sensor	Mounting height	Adjustment type		IP rating
			Knob	Dip	
1-8m (Knob)	2lux/ 25lux/ 2000lux	2-3m	x	x	IP20
4-10m	25lux/ 2000lux	2.5-6m	-	x	IP20
2m/ 4m/ 6m/ 8m	10lux / 30lux / 50lux / 2000lux	3.5m	-	x	IP20
1.5m/ 4m/ 6m/ 8m	10lux / 30lux / 50lux / 2000lux	3.5m	-	x	IP65
4-10m	3-2000lux	4-15m	x	-	IP20
5m/ 10m	25lux / 2000lux	3.5m	-	x	IP20
4m/ 8m	25lux/ 2000lux	3.5m	-	x	IP20
2m/ 6m/ 14m	10lux/ 50lux/ 200lux/ 2000lux	3.5m	-	x	IP20
2m/ 4m/ 6m/ 8m	20lux	3.5m	-	x	IP20
1-8m	2-2000lux	3.5m	-	x	IP20

# FLUSH & RECESSED CEILING MOUNTING

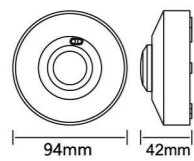

PS-RS01



PS-RS02SA



PS-RS19A-24V



PS-RS08A



PS-RS02A-1



PS-RS13A

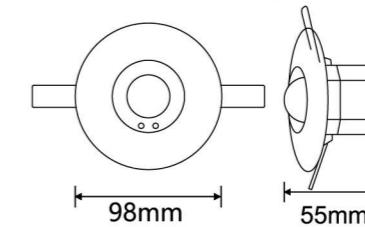

PS-RS16



Item No	Input voltage	Hold time
PS-RS01	220V-240V/AC, 110-130V/AC	8sec-12min
PS-RS19A-24V	9V, 12V, 24V/DC	8sec-12min
PS-RS02A-1	110-130V/AC, 220-240V/AC	8sec-12min
PS-RS02SA	110-130V/AC, 220-240V/AC	
PS-RS08A	110-130V/AC, 220-240V/AC	10sec/1min/5min/10min/15min/20min/25min/30min
PS-RS13A	110-130V/AC, 220-240V/AC	
PS-RS16	220V-240V/AC, 110-130V/AC, 12-30V/DC	

Detect distance (radii.)	Daylight sensor	Mounting height	Adjustment type		IP rating
			Knob	Dip	
2-10m	2-2000lux		×		IP20
2-10m	2-2000lux	3.5m	×	-	IP65
2-10m	2-2000lux	3.5m	×	-	IP65
		3.5m	-	×	IP65
2m / 5m / 8m / 10m	10lux / 20lux / 50lux / 100lux / 200lux / 300lux / 500lux / 2000lux	3.5m	-	×	IP65
2m / 5m / 8m / 10m	10lux / 20lux / 50lux / 100lux / 200lux / 300lux / 500lux / 2000lux	3.5m	-	×	IP65
				×	IP20

## DIMMING VERSION

- Auto start dimming mode at night without motion signal; auto exit when ambient light is over 100 lux (PS-RS28D, PS-RS29D)
- Auto start dimming mode at night without motion signal; auto exit when ambient light is over 200-300 lux (PS-RS27D, PS-RS27D-1, except 24h mode)
- Match up with most input 0-10V dimmable led driver on marketing (PS-RS08D and PS-RS34D)
- Match up with constant current & constant voltage driver (PS-RS27D, PS-RS27D-1, PS-RS28D, PS-RS29D)
- Match up with recommended POSA's led driver (PS-RS27D, PS-RS27D-1)

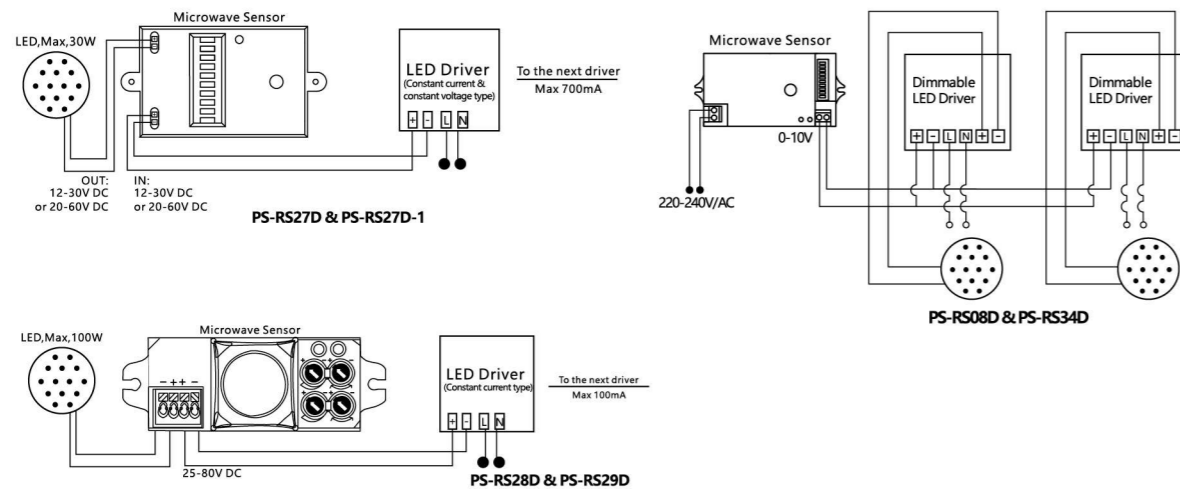

Item No	Input Voltage	Hold time	Brightness
PS-RS08D	220-240V/AC, 100-130V/AC	stay on	10%-60%
PS-RS09D	12-30V/DC, 20-60V/DC	1min-60min / 24h	0%-50%
PS-RS34D	90-260V/AC	1min / 30min / 60min / 24h	0% / 10% / 20% / 30%
PS-RS27D	12-30V/DC, 20-60V/DC	1min / 30min / 60min / 24h	0% / 10% / 20% / 30%
PS-RS27D-1	12-30V/DC, 20-60V/DC	1min / 30min / 60min / 24h	0% / 10% / 20% / 30%
PS-RS28D	25-80V/DC	stay on	0%-30%
PS-RS29D	25-80V/DC	stay on	0%-30%

## SENSOR COMBINE WITH LED DRIVER

- Integration of dimming microwave motion sensor, daylight sensor and LED power supply (PS-RS25D)
- Integration of microwave motion sensor, daylight sensor and LED power supply (PS-RS35, PS-RS36)
- Auto start dimming mode at night without motion signal; auto exit when ambient light is over 200-300 lux(except 24h mode) (PS-RS25D)

Item No	Input Voltage	Rated loading	Hold time	Brightness
PS-RS25D	180-240V/AC	LED 16W	1min / 30min / 60min / 24h	0% / 10% / 20% / 30%
PS-RS35	220-240V/AC, 100-130V/AC	LED 20W	/	/
PS-RS36	220-240V/AC, 100-130V/AC	LED 20W	/	/

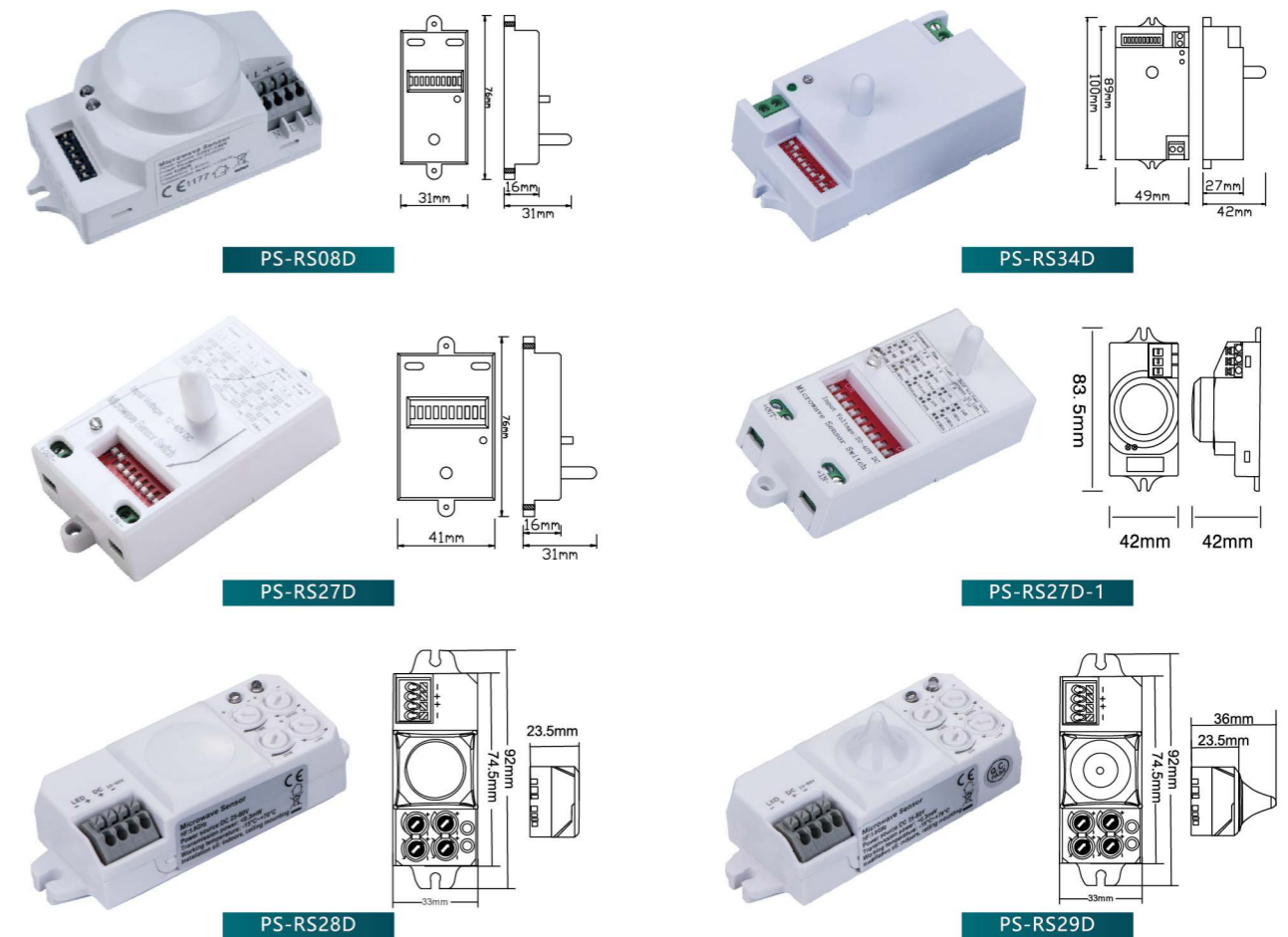

Hold time	Detect distance (radii.)	Daylight sensor	Adjustment type		IP rating
			Knob	Dip	
12sec / 3min / 15min / 30min	2m / 5m / 10m	10lux / 100lux / 500lux / 2000lux	x	-	IP20
8sec-12min	2-10m	2-2000lux			IP20
10sec / 1min / 5min / 10min	3m / 5m / 8m / 10m	10lux / 30lux / 50lux / 2000lux		x	IP20
10sec / 1min / 5min / 10min	3m / 5m / 8m / 10m	10lux / 30lux / 50lux / 2000lux		x	IP20
10sec / 1min / 5min / 10min	3m / 5m / 8m / 10m	10lux / 30lux / 50lux / 2000lux	x	x	IP20
8sec-12min	1-8m	10-1000lux	x		IP20
8sec-12min	1-8m	10-1000lux	x		IP20

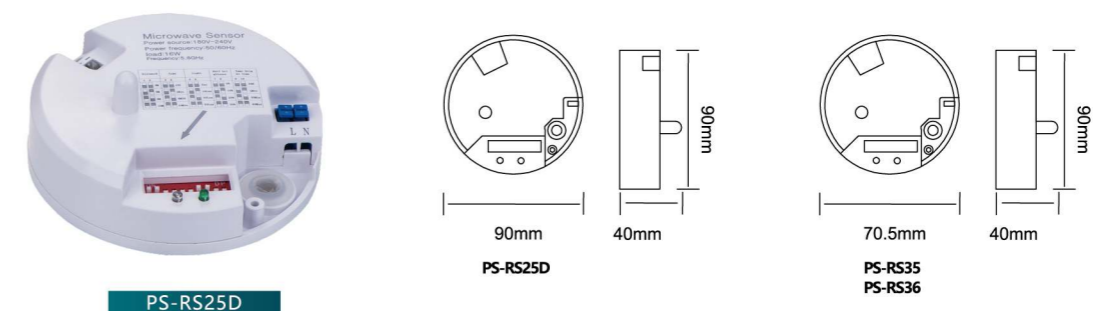

Hold time	Detect distance (radii.)	Daylight sensor	Adjustment type		IP rating
			Knob	Dip	
10sec / 1min / 5min / 10min	3m / 5m / 8m / 10m	10lux / 30lux / 50lux / 2000lux		x	IP20
10sec / 1min / 5min / 10min	3m / 5m / 8m / 10m	10lux / 30lux / 50lux / 2000lux		x	IP20
10sec-10min	2-10m	2-2000lux	x		IP20



# RF COMMUNICATION VERSION COMBINE WITH LED DRIVER

- Integration of microwave motion sensor with RF communication function, stand-by dimming function, daylight sensor and LED power supply
- RF transmission up to 20m in open area
- 6 dips for group setting, up to 64 groups possible. With the dip code easily set the same address code to have group illumination function

Item No	Input Voltage	Rated loading	Hold time	Brightness
PS-RS26D	220-240V/AC, 110-130V/AC	LED 16W	24h / 30s / 1min / 5min / 10min / 30min / 1h / 2h	0% / 5% / 10% / 20% / 30% / 40% / 50% / 60%
PS-RS26D-1	220-240V/AC, 110-130V/AC	LED 16W	24h / 1min / 3min / 5min	0% / 10% / 20% / 30%



PS-RS26-1D



PS-RS26D

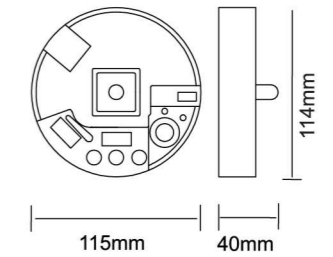

Hold time	Detect distance (radii.)	Daylight sensor	Adjustment type		IP rating
			Knob	Dip	
8sec - 12min	2-10m	10-2000LUX		×	IP20
10sec / 1min / 3min / 5min	2m / 5m / 8m / 10m	10lux / 30lux / 50lux / 2000lux	×	×	IP20

# RF COMMUNICATION VERSION

- Integration of microwave motion sensor with RF communication function, stand-by dimming function and daylight sensor
- RF transmission up to 20m in open area
- 6 dips for group setting, up to 64 groups possible. With the dip code easily set the same address code to have group illumination function

Item No	Input Voltage	Rated loading	Hold time	Brightness
PS-RS30D	220-240V/AC, 110-130V/AC	max. 3A, 20-60V (output)	24h / 1min / 3min / 5min	0% / 10% / 20% / 30%



PS-RS30D

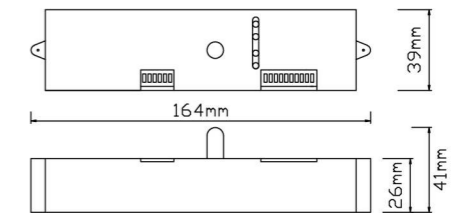

Hold time	Detect distance (radii.)	Daylight sensor	Adjustment type		IP rating
			Knob	Dip	
10sec / 1min / 3min / 5min	2m / 5m / 8m / 10m	10lux / 30lux / 50lux / 2000lux		×	IP20



**RECESSED FLUSH CEILING MOUNTED VERSION**

**SURFACE CEILING MOUNTED VERSION**



PS-SS200A

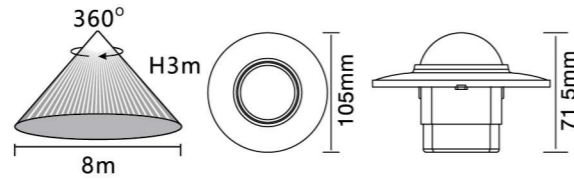

Item No :	<b>PS-SS200A</b>
Input Voltage:	220V-240V/AC
Time Delay:	8sec~7min
Detect Distance:	< 8m
Light Control:	3~2000lux
Rated Load:	💡 1200W 💡 300W



PS-SS20B

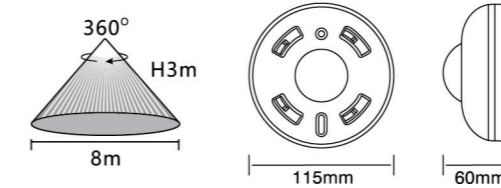

Item No :	<b>PS-SS20B</b>
Input Voltage:	220V-240V/AC
Time Delay:	5sec/1min/5min/8min
Detect Distance:	< 8m
Light Control:	10lux
Rated Load:	💡 1200W 💡 300W



PS-SS41

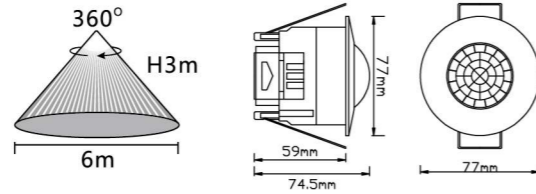

Item No :	<b>PS-SS41</b>
Input Voltage:	220V-240V/AC
Time Delay:	10sec~7min
Detect Distance:	< 6m
Light Control:	3~2000lux
Rated Load:	💡 1200W 💡 300W



PS-SS28A

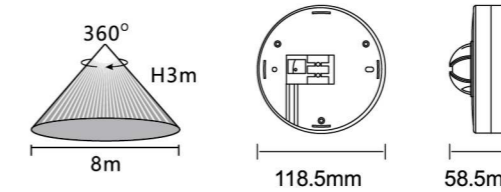

Item No :	<b>PS-SS28A</b>
Input Voltage:	220V-240V/AC, 12V/DC, 24V/DC
Time Delay:	8sec~7min
Detect Distance:	< 8m
Light Control:	3~2000lux
Rated Load:	💡 1200W 💡 300W



PS-SS49

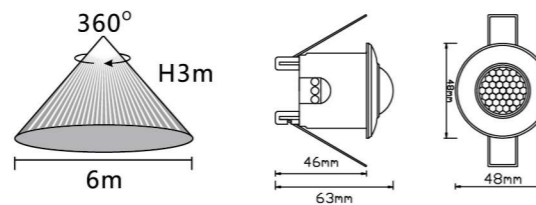

Item No :	<b>PS-SS49</b>
Input Voltage:	220V-240V/AC
Time Delay:	10sec~7min
Detect Distance:	< 6m
Light Control:	3~2000lux
Rated Load:	💡 1200W 💡 300W



PS-SS28B

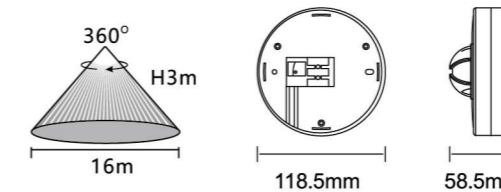

Item No :	<b>PS-SS28B</b>
Input Voltage:	220V-240V/AC
Time Delay:	8sec~7min
Detect Distance:	< 16m
Light Control:	3~2000lux
Rated Load:	💡 1200W 💡 300W



PS-SS91

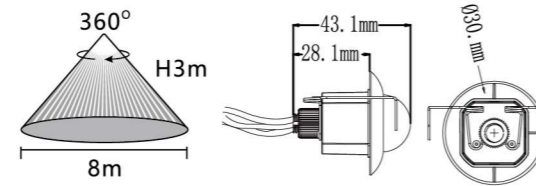

Item No :	<b>PS-SS91</b>
Input Voltage:	220-240V/AC
Time Delay:	1min
Detect Distance:	< 8m
Light Control:	<10LUX
Rated Load:	💡 1200W 💡 300W



PS-SS29A

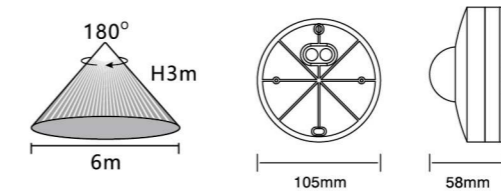

Item No :	<b>PS-SS29A</b>
Input Voltage:	220V-240V/AC
Time Delay:	10sec~7min
Detect Distance:	< 6m
Light Control:	3~2000lux
Rated Load:	💡 1200W 💡 300W



PS-SS29B

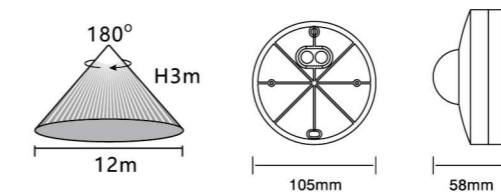

Item No :	<b>PS-SS29B</b>
Input Voltage:	220V-240V/AC
Time Delay:	10sec~7min
Detect Distance:	< 12m
Light Control:	3~2000lux
Rated Load:	💡 1200W 💡 300W

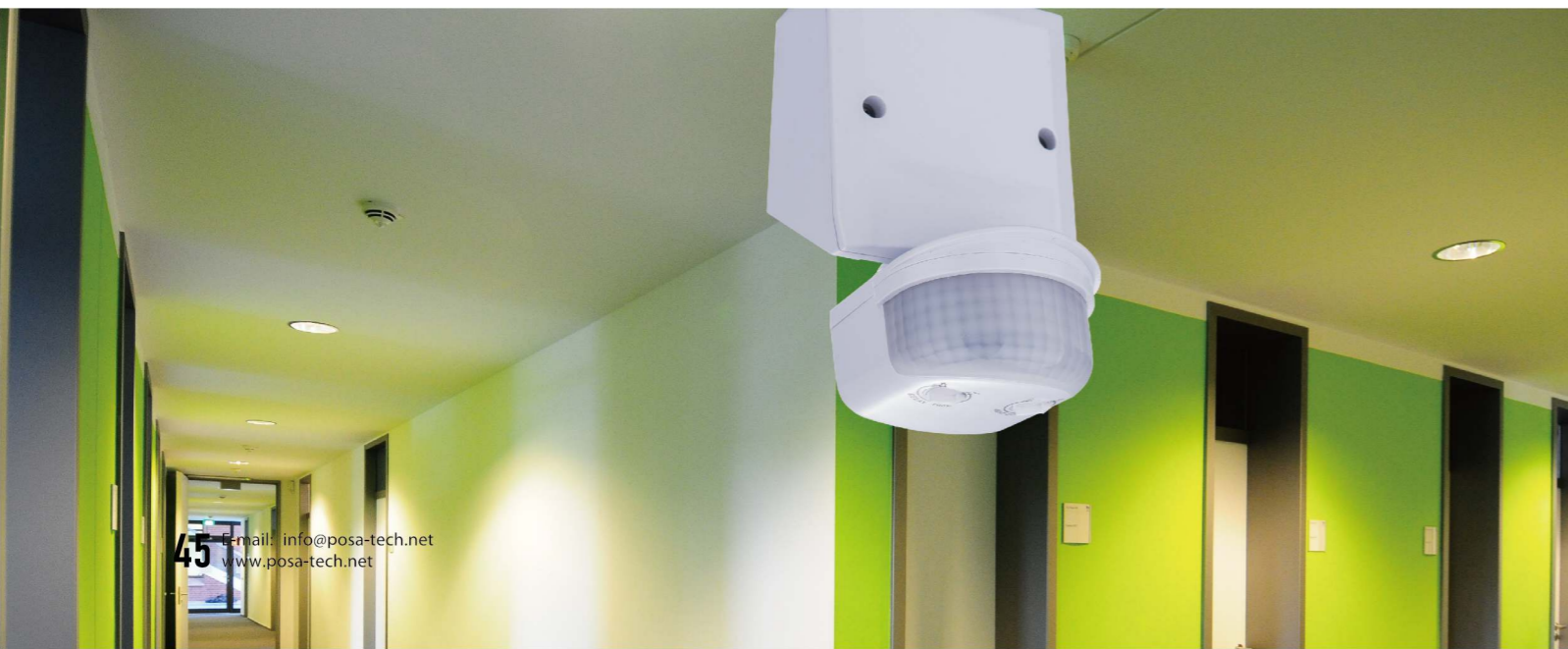

**SURFACE WALL MOUNTED VERSION, IP44**

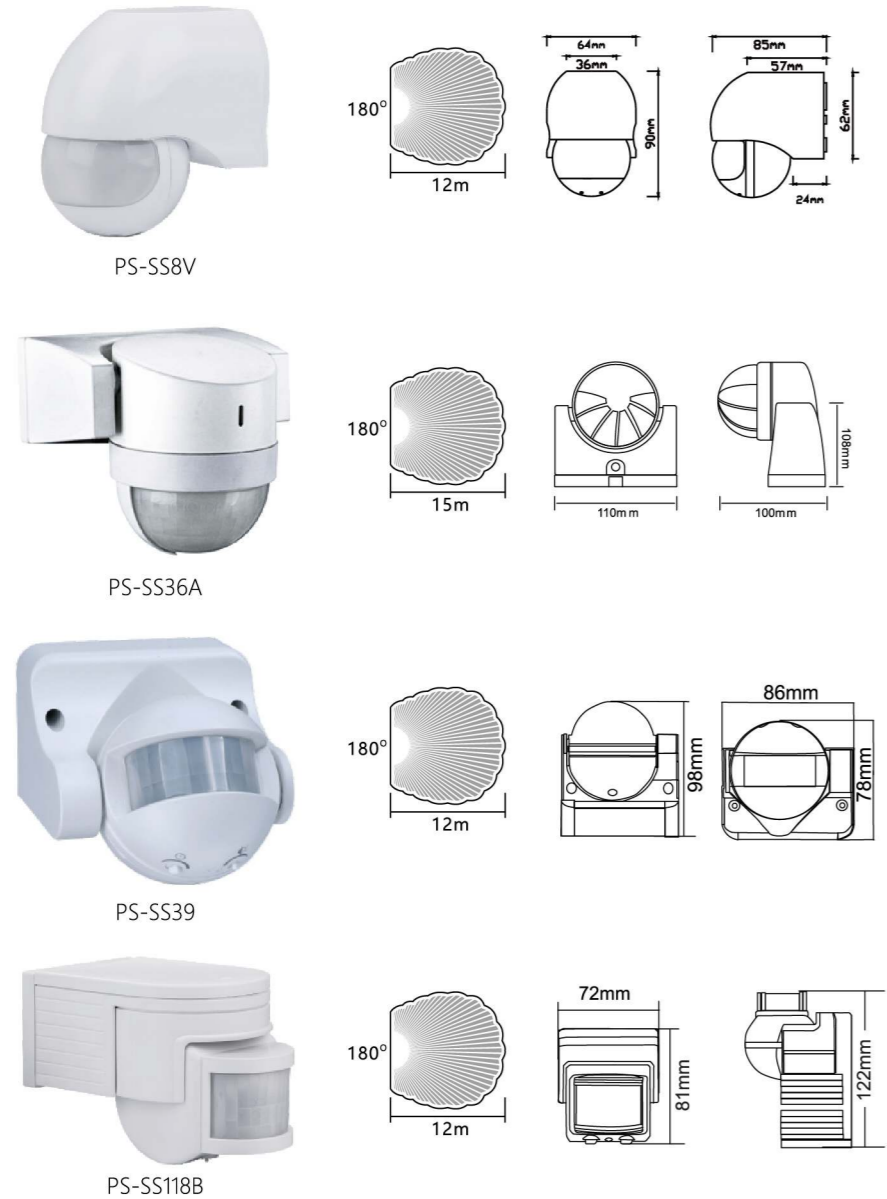

Item No :	<b>PS-SS8V</b>
Input Voltage:	220V-240V/AC
Time Delay:	10sec~7min
Detect Distance:	5~12m
Light Control:	2~2000lux
Rated Load:	💡 1200W 💡 300W

Item No :	<b>PS-SS36A</b>
Input Voltage:	220V-240V/AC
Time Delay:	10sec~6-9min
Detect Distance:	< 15m
Light Control:	15~2000lux
Rated Load:	💡 3000W 💡 300W

Item No :	<b>PS-SS39</b>
Input Voltage:	220V-240V/AC
Time Delay:	8sec~8min
Detect Distance:	2-12m
Light Control:	3~2000lux
Rated Load:	💡 1200W 💡 300W

Item No :	<b>PS-SS118B</b>
Input Voltage:	220V-240V/AC
Time Delay:	8sec~7min
Detect Distance:	< 12m
Light Control:	3~2000lux
Rated Load:	💡 1200W 💡 300W

**SENSOR LAMPHOLDER**

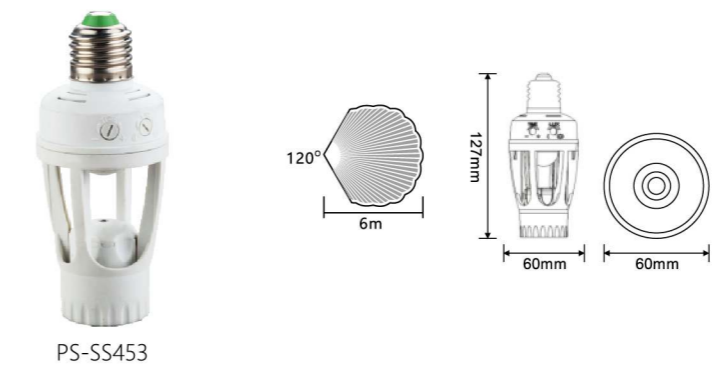

Item No :	<b>PS-SS453</b>
Input Voltage:	220V-240V/AC
Time Delay:	10sec~2min
Detect Distance:	< 6m
Light Control:	3~2000lux
Rated Load:	💡 60W 💡 20W

**ATTACHABLE SENSOR VERSION**

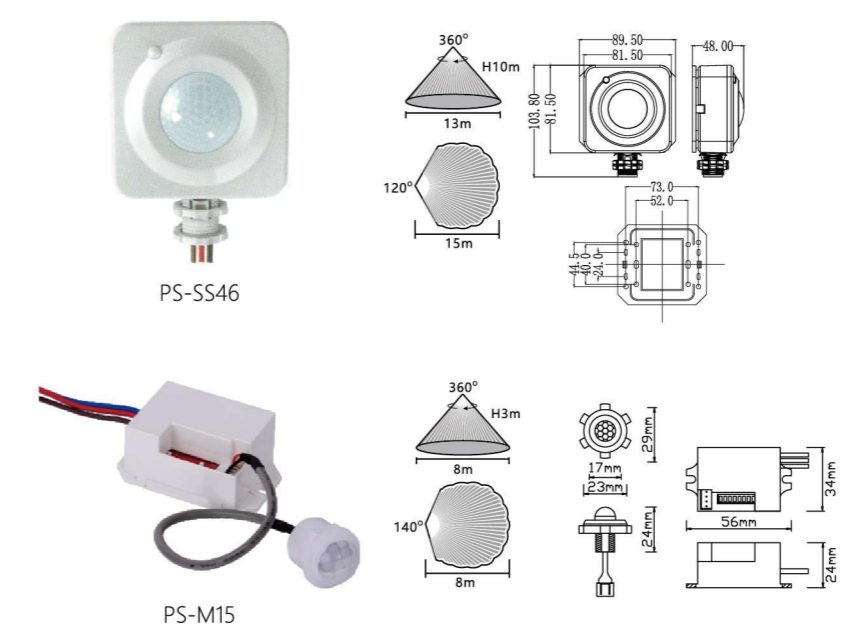

Item No :	<b>PS-SS46</b>
Input Voltage:	85V-265V/AC
Time Delay:	3min~30min
Detect Distance:	13m (ceiling installation) 15m (wall installation)
Light Control:	< 50lux
Rated Load:	💡 2000W 💡 800W

Item No :	<b>PS-M15</b>
Input Voltage:	220-240V/AC
Time Delay:	5sec/30sec/1min/ 3min/5min/8min
Detect Distance:	< 8m
Light Control:	10/2000lux
Rated Load:	💡 800W 💡 150W

**SENSOR SWITCH & VOICE DETECT VERSION**

- multi-working mode: on/off/infrared detection/infrared detection+sound control mode
- Sound control sensibility: 30db-90db, adjustable

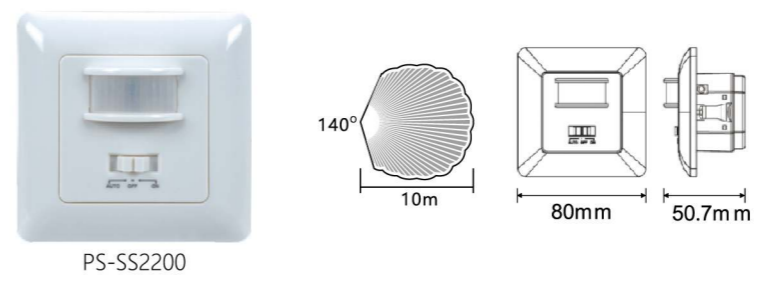

Item No :	<b>PS-SS2200</b>
Input Voltage:	90V-240V/AC
Time Delay:	10sec~10min
Detect Distance:	< 10m
Light Control:	3~1000lux
Rated Load:	💡 500W 💡 100W

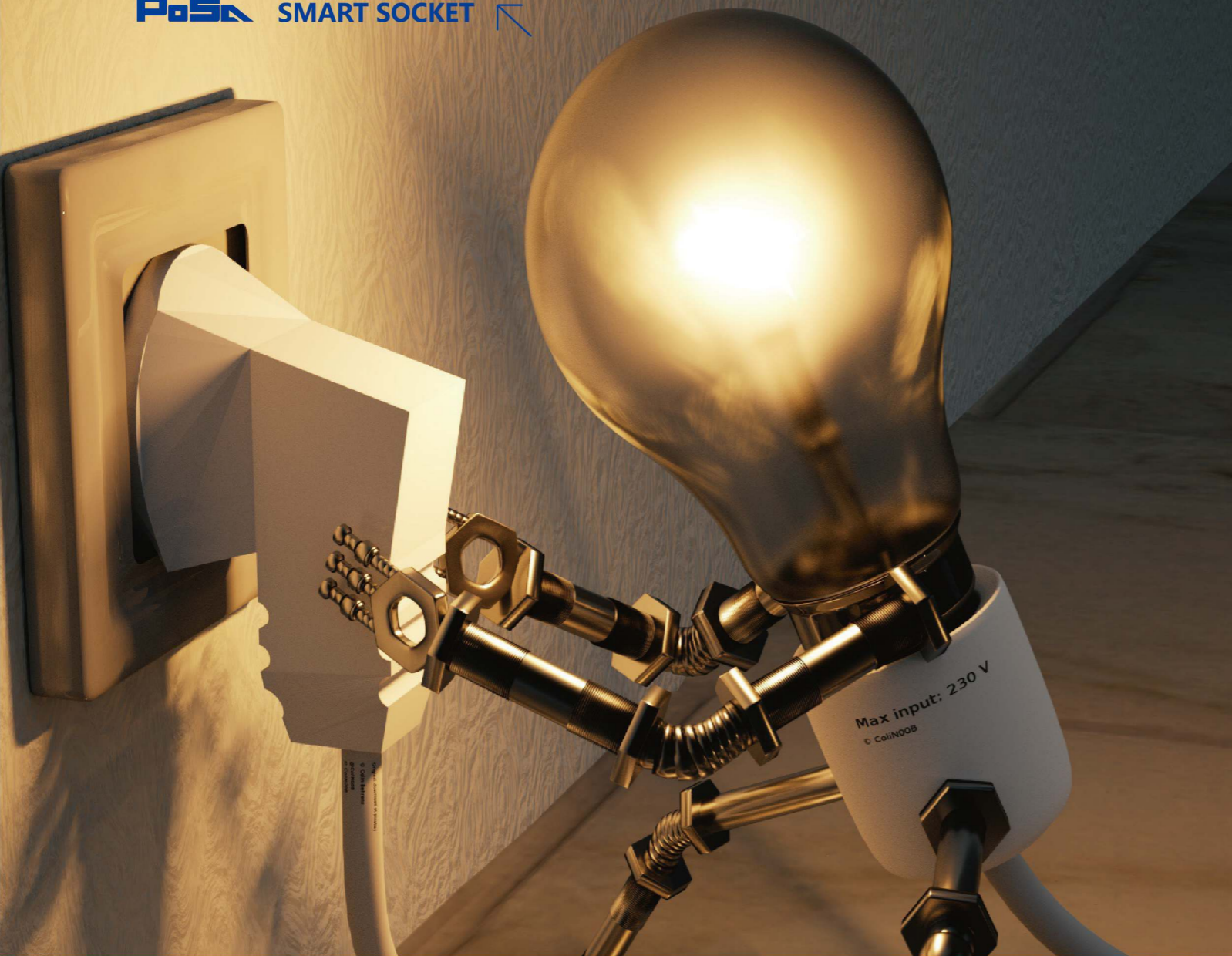

### REMOTE CONTROL SOCKET

- Self learning system
- Voltage: 240V/50Hz
- Max power: 3680W
- Max current: 16A
- Transmission frequency: 433.92MHZ

#### Multiple combination:

- 1 socket + 1 remote
- 2 sockets + 1 remote
- 3 sockets + 1 remote
- 4 sockets + 1 remote
- 4 sockets + 2 remotes
- 2 sockets + 2 remotes

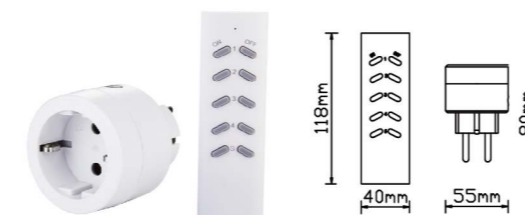

Item NO	Meas	IP
PA-GE9A-01SRF3	55*55*97mm	IP20



Item NO	Meas	IP
PA-GE1-01SRFP2	40*113*85mm	IP44



Item NO	Meas	IP
PA-GEB-01SRFP	50*117*72mm	IP44



Item NO	Meas	IP
PA-GE9A-01SRF3	55*55*97mm	IP20

### STANDY KILLER POWER SAVING SOCKET

- Perfect energy efficient item, can kill the standby power of all connected appliances to zero watt automatically
- "Self-learning" type, perfect for all types of AV, PC equipments and their accessory devices
- With surge protection function, anti lightning strikes, prolong the service life of product itself and connected device
- With over load protection function, can avoid connected home appliances and product itself are damaged by sudden highcurrent, short circuit or over load etc causes .
- "Intelligent IR" control, can self-learn and record its standby power for all kinds of TVs, PCs, air conditioners etc. So the itemwill automatically cut off the power supply when detect the change of current for master device TV, PC host
- With one master outlet, four slave outlet
- The slave devices in slave socket position will be turned on automatically when master device turns on so the slave devicesin slave socket position will be turned off automatically when master device turns off

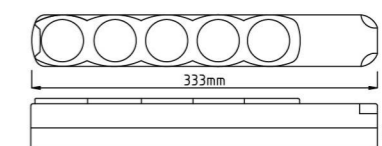

Item No	Input voltage	Max loaded power	Maximum load of the master	Time of disconnected	Time of connect	Overload protection
PS-SK18G	220-240V/AC 110-130V/AC	2300W	500W	15S	1min	10A

## SMART SOCKET

